

Optimal Audio



USER GUIDE

# Zone 8

8 zone audio controller with DSP and WebApp

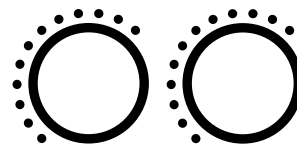

Controllers

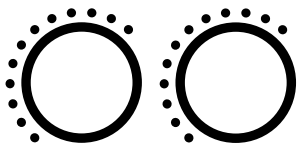

Controllers

# Zone 8

8 zone audio controller with DSP and WebApp

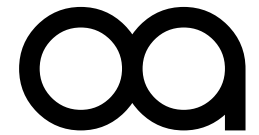

Optimal Audio



Congratulations on your choice of Optimal Audio for your latest sound system installation.

The Optimal Audio range of compatible audio zoners, amplifiers and loudspeakers are designed to work together simply and effectively. Our quick start guides will take you through the simple connection and set up procedure.

Zone 8 is a powerful and flexible audio signal router and processor that is the heart of your system. It has been designed to be easy to set up and operate, even if you have very little previous experience of similar equipment.

With Zone 8 it is possible to combine audio sources such as streaming services, radio, computer audio or anything with an audio output and create separate mixes in up to eight separate zones. Zones can be thought of as different rooms or areas where you would want to establish a different musical ambience. For ideas on how this might work for you, be sure to check out our Optimal Audio Application examples on [optimal-audio.co.uk](https://optimal-audio.co.uk)

This quick start guide will help you get up and running as quickly as possible, with minimum fuss, and ensure you get the best results from your system.

## Helpful Tip

Prior to installation of Zone, please check for latest **firmware update**.

<https://optimal-audio.co.uk/support/software>

## USER GUIDE

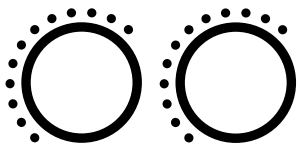

Controllers

# Zone 8

8 zone audio controller with DSP and WebApp

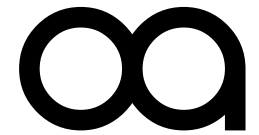

Optimal Audio



All Zone products have the same input capacity across the range:  
Four stereo line inputs allow the connection of sound sources such as streamers, CD players, laptops or anything that has a stereo analogue audio output.

Two standard HDMI connectors to provide simple connectivity with whichever audio-visual equipment you use.

Two microphone inputs with 48V phantom power.

Two inputs for future Optimal Audio paging stations, or to connect additional ZonePad 4 wall controllers.

Zone 8 has eight mono line outputs – these can be configured as four stereos. The Zone 8P also has eight integral channels of amplification.

Both models have the ability to accept connections with up to eight ZonePad 1 or ZonePad 4 wall-mounted controllers.

---

## USER GUIDE

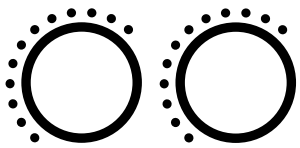

Controllers

# Zone 8

8 zone audio controller with DSP and WebApp

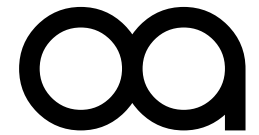

Optimal Audio

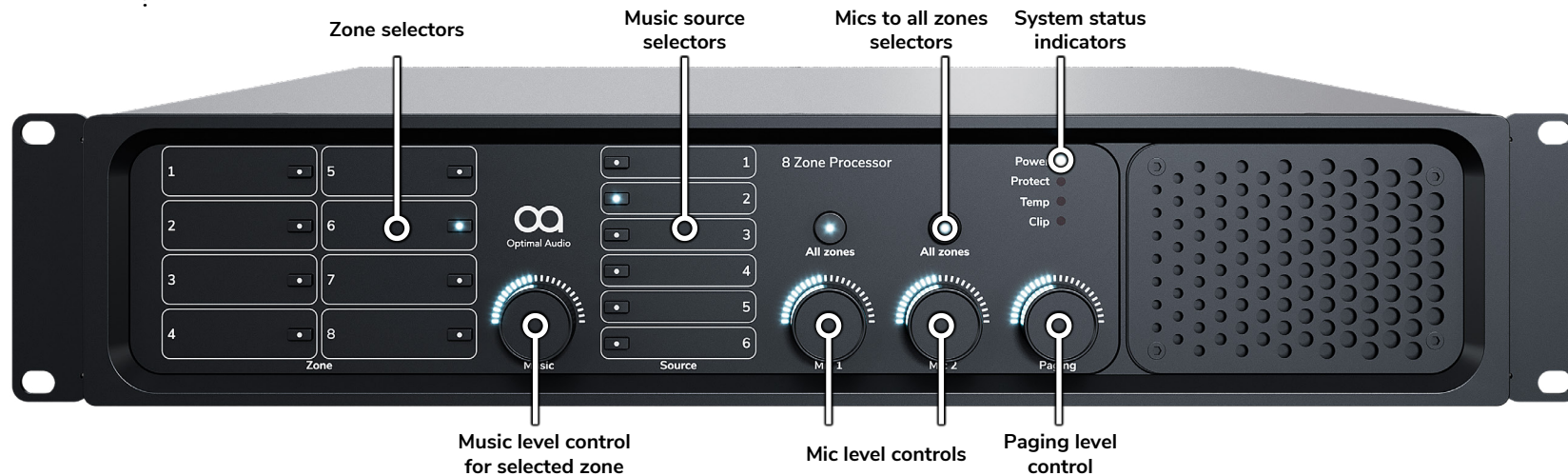

## Front panel

The zone selector buttons allow you to choose which zone of your system you wish to adjust. There's plenty of space for a label to make sure you know exactly which part of the system you are controlling.

Once you have selected your zone, the bar perhaps, you can then choose which music source you want to adjust. Again, space is there for clear labelling.

The music level control will then allow you to adjust the level of your chosen source, in your chosen zone.

In addition, the two microphone inputs have individual level controls to enable your message to be heard at just the right volume in each zone. Just select the zone and adjust the relevant mic level control.

Should you wish to control the levels of all zones at once, hit the button above the knob for either Mic 1 or 2.

And finally, there is a volume control for the paging stations.

System status indicators give you an easy visual read out of how the Zone 8 is behaving, with a power indicator, protect, temperature warning and signal overload, or clip indicators.

Power light status colours	
Green:	Unit operational, no network or static IP address
White:	Unit operational with DHCP IP address
Steady orange:	Alarm mute active
Flashing orange:	firmware update in progress. Zone selection light(s) will also flash if Wall controller firmware is being updated
Red:	An error has occurred. Refer to support for details.
For a full list of colours and meanings, please visit <a href="http://optimal-audio.co.uk">optimal-audio.co.uk</a>	

## USER GUIDE

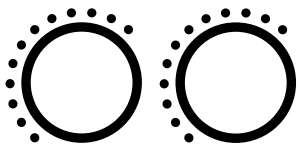

Controllers

# Zone 8

8 zone audio controller with DSP and WebApp

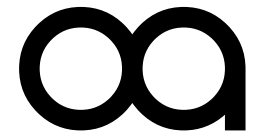

Optimal Audio

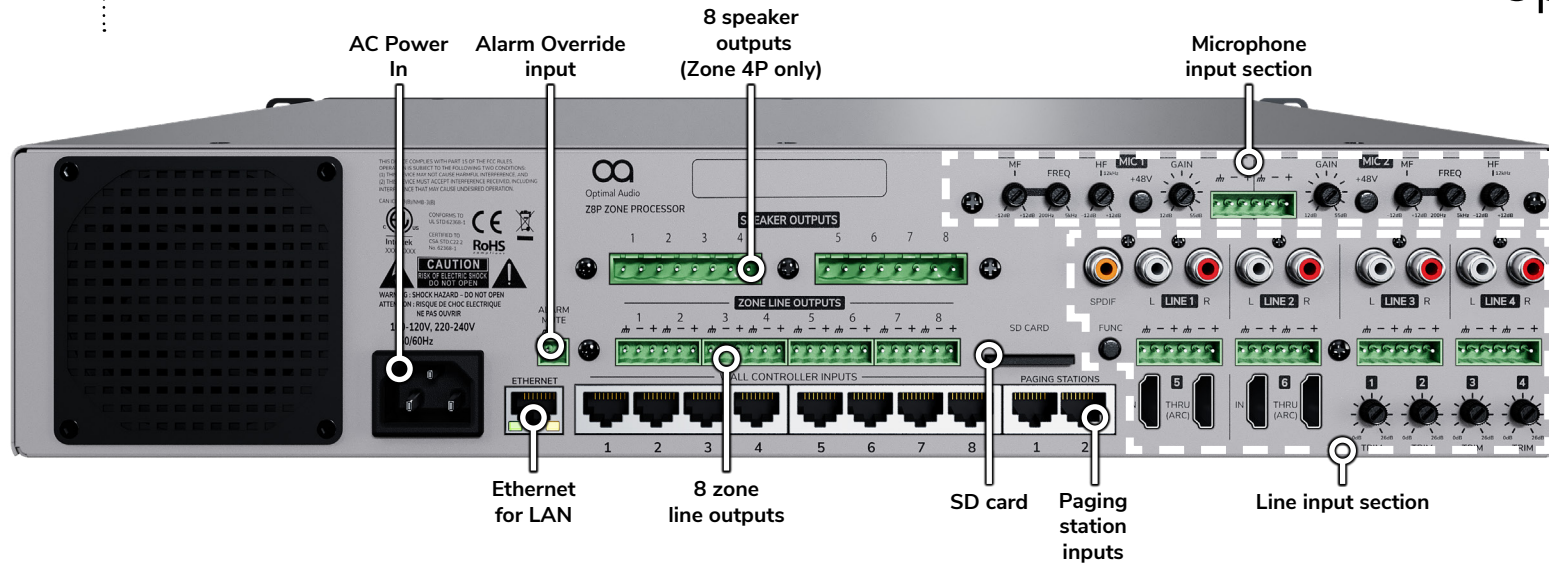

## Rear panel

A standard IEC mains connector supplies the unit with AC power between 100 and 240 volts.

The ethernet socket allows you to connect Zone 8 to a router to give you wired or wireless control via the Optimal Audio WebApp.

An alarm override ensures that any alarm system will mute all outputs via contact closure.

Up to eight Optimal Audio ZonePad wall controllers are connected via standard RJ45 connectors, using a proprietary Optimal Audio protocol to provide power, data and audio over CAT 5 cable.

Zone 8 delivers audio to eight separate outputs – your zones. These can also be configured as four stereo outputs in WebApp if you wish.

Zone 8P differs from Zone 8 with the addition of eight loudspeaker outputs, allowing you to run one 4 ohm, two 8 ohm or four 16 ohm loudspeakers on each output. The Zone 8P will deliver a total of 100W of power into the loudspeakers on each output.

The SD card slot can be accessed to transfer your settings to another Zone 8 via a standard SD card. This is useful for those installations that require a number of devices to perform very similar functions or repeat system configurations across several venues.

Zone 8 has two inputs for future paging stations, again using Optimal Audio proprietary protocol over standard CAT5 cable. These inputs can also be used for additional ZonePad 4 units.

Two microphone inputs are provided, four stereo line inputs and two stereo HDMI inputs thru sockets carrying the Audio Return Channel (ARC) signal.

## USER GUIDE

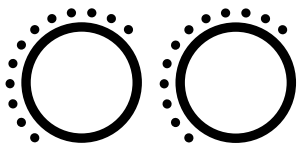

Controllers

# Zone 8

8 zone audio controller with DSP and WebApp

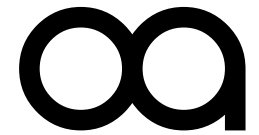

Optimal Audio



Input section detail – mic inputs –  
Input 1 only shown for clarity  
(controls are repeated for mic input 2)

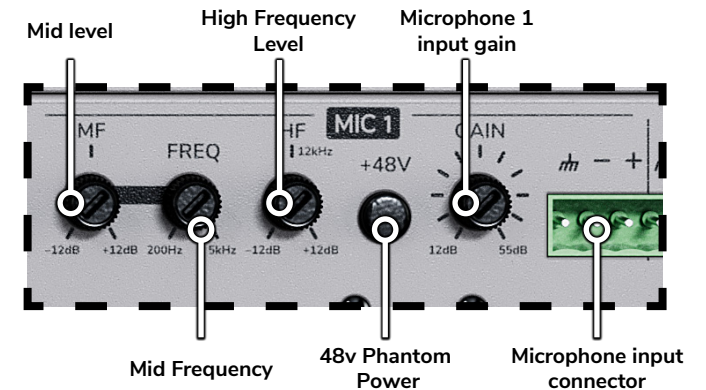

## Microphone inputs

The two inputs are identical apart from the fact that the controls are laid out as a mirror of each other.

Immediately adjacent to the input connectors are the mic input gain controls. Correct gain adjustment for your microphone is essential to ensure good signal control throughout your system. Generally speaking, dynamic microphones will require more gain than condenser microphones.

The 48V Phantom Power button will allow you to use high-quality condenser mics with Zone 8. If you are using a condenser mic, engage Phantom Power for your mic to function.

The next three controls are for setting a basic equalization for your mic input. They are independent of any equalization in WebApp. These are useful for tailoring your sound to a particular voice/microphone combination. Use the

High frequency control for increasing or decreasing sibilance, which can help with intelligibility. The mid-range controls allow you to choose the frequency around which you can boost or cut, between 200Hz and 5kHz. The lower mid frequencies will affect warmth and muddy sounding voices, the middle range will help to stop 'boxiness', and the higher frequencies will assist with intelligibility or harshness. Experiment to find out what suits your requirement.

## USER GUIDE

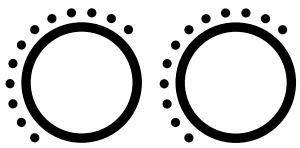

Controllers

# Zone 8

8 zone audio controller with DSP and WebApp

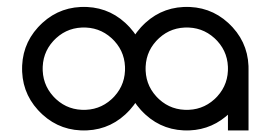

Optimal Audio

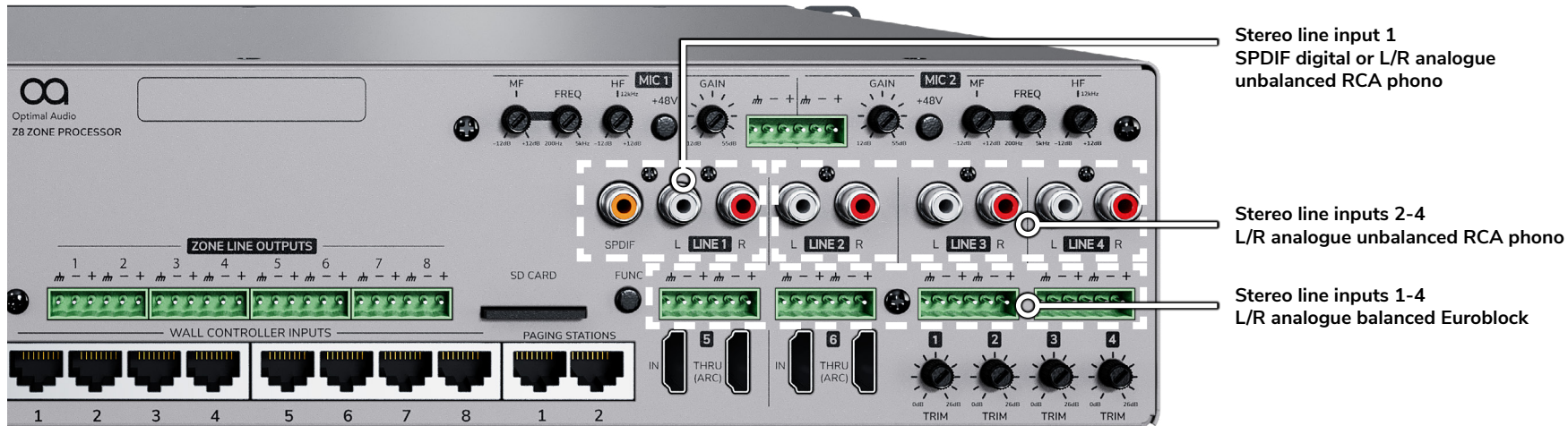

## Line inputs

Below the mic inputs are the connections for line inputs 1 – 4

These are where the outputs of your music sources will be plugged in to Zone 8.

They are all identical except for Line Input 1. All are stereo analogue inputs, however Input 1 also has the option to use a standard SPDIF digital audio connection, which will give you full stereo reproduction on a single cable when connected with compatible equipment. This is clearly labelled and features an orange phono socket.

Each input has a standard red and white coloured pair of RCA phono sockets for connecting units which are placed locally to the Zone 8, such as a streamer in the same equipment rack. These inputs are not suitable for connection of equipment located remotely from the Zone 8. For this purpose, use the four stereo balanced line inputs on the euroblock connectors.

For the connection of more remote sound sources there are four stereo balanced line inputs on Euroblock connectors. In all cases you should decide which you are going to use before hooking up, and never use two different types of connection at the same time on the same input!

It is possible to have more than one source connected to each input via the different connections. Obviously, you would not want to have more than one source running simultaneously, as you would end up with a jumbled noise. If you do use this facility, care will need to be taken about the input gain setting, as this is common for all connections on each input.

To the right of the HDMI inputs are four gain trim controls for inputs 1 – 4. These give you the ability to adjust the inputs to accept a signal from consumer level at -10dBV maximum to pro level +20dBu maximum.

## USER GUIDE

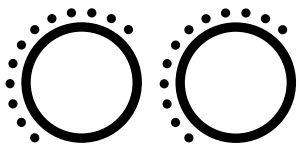

Controllers

# Zone 8

8 zone audio controller with DSP and WebApp

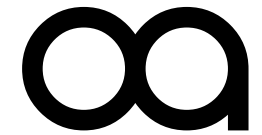

Optimal Audio

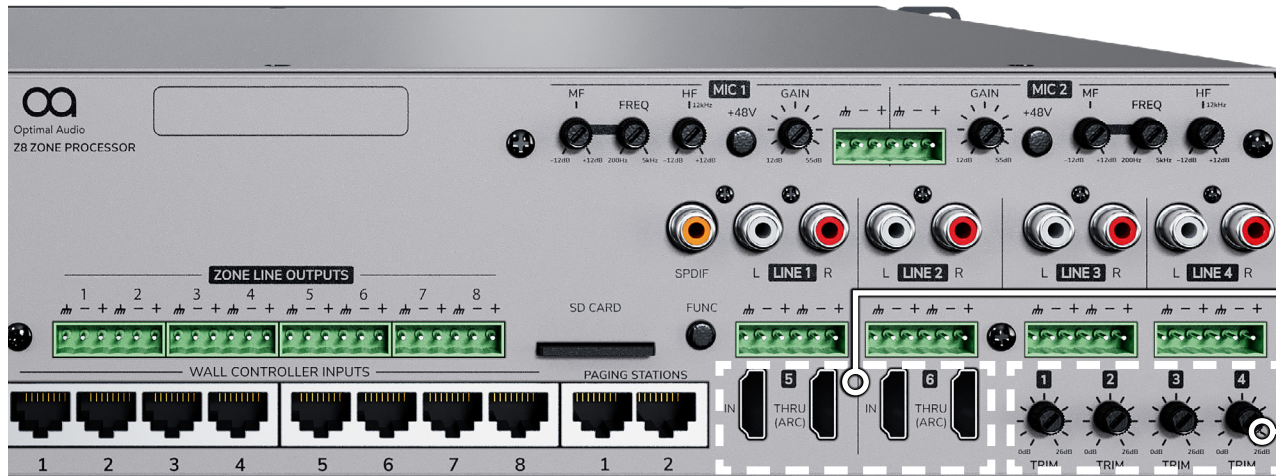

Stereo line inputs 5&6  
HDMI in THRU

Input level for stereo line inputs 1-4

## Line inputs

Below the Euroblock inputs are two HDMI sockets for line inputs 5 and 6, and two associated THRU sockets.

The HDMI inputs give you the ability to plug directly in to Zone from the HDMI output of a cable or satellite box, a projector or laptop.

The HDMI input can take a standard HDMI signal (audio and video) and it strips off the audio for processing in Zone.

The THRU signal can then send the video signal only (no audio) through to a display.

All the Euroblock connectors you will need to connect up Zone 8 are supplied with the unit, as is the relevant mains power cable for your location. The RCA phono and HDMI connections are all standard and readily available to purchase.

For wiring guides for balanced and unbalanced audio connections please refer to our Connectors and Cables, Lights and Labels manual on [optimal-audio.co.uk](http://optimal-audio.co.uk)

## USER GUIDE



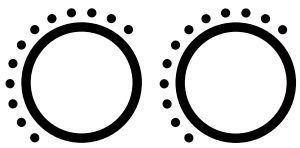

Controllers

# Zone 8

8 zone audio controller with DSP and WebApp



Optimal Audio



## WARNING!

**DO NOT EXPOSE THIS EQUIPMENT TO RAIN OR MOISTURE**

This symbol is intended to alert the user to the presence of important operating and maintenance (servicing) instructions in the literature accompanying the appliance.



## CAUTION

**RISK OF ELECTRIC SHOCK  
DO NOT OPEN**

This symbol is intended to alert the user to the presence of uninsulated "dangerous voltage" within the product's enclosure that may be of sufficient magnitude to constitute a risk of electric shock to persons.

**THIS EQUIPMENT MUST BE EARTHED**

## Important Safety Instructions

1. Read these instructions.
2. Keep these instructions.
3. Heed all warnings.
4. Follow all instructions.
5. Do not use this apparatus near water.
6. Clean only with a dry cloth.
7. Do not block any ventilation opening. Install in accordance with the manufacturer's instructions.
8. Do not install near any heat sources such as radiators, heat registers, stoves, or other apparatus (including amplifiers) that produce heat.
9. To reduce the risk of electrical shock, the power cord shall be connected to a mains socket outlet with a protective earthing connection.
10. Do not defeat the safety purpose of the polarized or grounding type plug. A polarized plug has two blades with one wider than the other. A grounding type plug has two blades and a third grounding prong. The wide blade or the third prong are provided for your safety. If the provided plug does not fit into your outlet, consult an electrician for replacement of the obsolete outlet.
11. Protect the power cord from being walked on or pinched particularly at plugs, convenience receptacles, and the point where they exit from the apparatus.
12. Do not unplug the unit by pulling on the cord, use the plug.
13. Unplug this apparatus during lightning storms or when unused for long periods of time.
14. Refer all servicing to qualified service personnel. Servicing is required when the apparatus has been damaged in any way, such as power supply cord or plug is damaged, liquid has been spilled or objects have fallen into the apparatus, the apparatus has been exposed to rain or moisture, does not operate normally, or has been dropped.
15. The appliance coupler, or the AC Mains plug, is the AC mains disconnect device and shall remain readily accessible after installation.
16. The apparatus shall not be exposed to dripping or splashing and no objects filled with liquids, such as vases, shall be placed on the apparatus.
17. Do not remove any covers, loosen any fixings or allow items to enter any aperture.

## FCC Compliance

This device complies with part 15 of the FCC Rules. Operation is subject to the following two conditions:

1. This device may not cause harmful interference.
2. This device must accept any interference received, including interference that may cause undesired operation.

**Note:** This equipment has been tested and found to comply with the limits for a Class B digital device, pursuant to part 15 of the FCC Rules. These limits are designed to provide reasonable protection against harmful interference in a residential installation. This equipment generates uses and can radiate radio frequency energy and, if not installed and used in accordance with the instructions, may cause harmful interference to radio communications.

## USER GUIDE

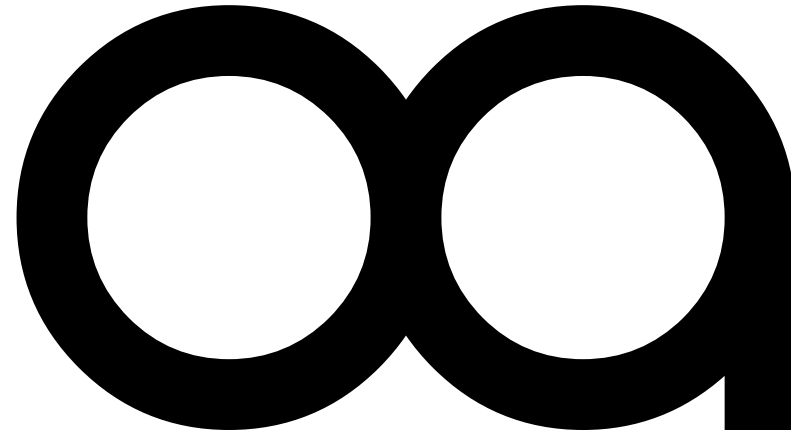

**Relax, It's Optimal Audio.**

[optimal-audio.co.uk](http://optimal-audio.co.uk)

**Optimal Audio Group Ltd.**  
Century Point, Halifax Road,  
Cressex Business Park,  
High Wycombe,  
Buckinghamshire,  
HP12 3SL