



User Manual

ATDM-1012
DIGITAL SMARTMIXER

ATDM-1012DAN
DIGITAL SMARTMIXER with Dante

Introduction

Thank you for purchasing this Audio-Technica product.

Before using the product, read through the Quick Start Guide and refer to this user manual as necessary to ensure that you will use the product correctly.

Checking the package contents

Before use, check to make sure that all of the following items are contained in the package.

If any of the items is missing from your package or damaged, contact your local Audio-Technica dealer.

- ATDM-1012/ATDM-1012DAN unit
- Euroblock connector x22
- Power cable
- Quick Start Guide

Trademarks

- SMARTMIXER™ is a trademark or registered trademark of Audio-Technica Corporation.
- Apple and the Apple logo are trademarks of Apple Inc., registered in the U.S. and other countries.
- iOS is a trademark or registered trademark of Cisco in the U.S. and other countries.
- App Store is a service mark of Apple Inc.
- Google, the Google logo, Google Play, the Google Play logo, and Android™ are trademarks or registered trademarks of Google Inc.
- All other company and product names that appear in this document are trademarks or registered trademarks of their respective owners.

Safety precautions

Important information





Warning:

To prevent fire or shock hazard, do not expose this apparatus to rain or moisture.

Caution:

- Do not expose this apparatus to drips or splashes.
- To avoid electric shock, do not open the cabinet.
- Refer servicing to qualified personnel only.
- Do not expose this apparatus to excessive heat such as that generated by sunshine, fire or other heat sources.
- Do not subject this apparatus to strong impact.
- This apparatus should be located close enough to the AC outlet so that you can easily grasp the power cord plug at any time. In case of emergency, disconnect the power cord plug of this apparatus quickly.
- Do not place any objects filled with liquids, such as vases, on this apparatus.
- To prevent fire, do not place any naked flame sources (such as lighted candles) on this apparatus.
- Do not install this apparatus in a confined space such as a bookcase or similar unit.
- Install this apparatus only in places with good ventilation.
- To prevent fire, do not cover the ventilation of this apparatus with newspapers, tablecloths, curtains, etc.
- This apparatus with Class I construction shall be connected to an AC outlet with a protective grounding connection.

For customers in the USA/Canada

	CAUTION RISK OF ELECTRIC SHOCK DO NOT OPEN	
Caution: To prevent electric shock, do not remove the cover. There are no user-serviceable parts inside. Internal adjustments are for qualified professionals only. Refer all servicing to qualified service personnel.		
	The lightning flash with arrowhead symbol, within an equilateral triangle, is intended to alert the user to the presence of uninsulated "dangerous voltage" within the product's enclosure that may be of sufficient magnitude to constitute a risk of shock to persons.	
	The exclamation point symbol within an equilateral triangle is intended to alert the user to the presence of important operating and maintenance (servicing) instructions in the literature accompanying the product.	

Important Safety Instructions

- 1) Read these instructions.
- 2) Keep these instructions.
- 3) Heed all warnings.
- 4) Follow all instructions.
- 5) Do not use this apparatus near water.
- 6) Clean only with dry cloth.
- 7) Do not block any of the ventilation openings. Install in accordance with the manufacturer's instructions.
- 8) Do not install near any heat sources such as radiators, heat registers, stoves, or other apparatus (including amplifiers) that produce heat.
- 9) Do not defeat the safety purpose of the polarized or grounding plug. A polarized plug has two blades with one wider than the other. A grounding plug has two blades and a third grounding prong. The wide blade or the third prong is provided for your safety. If the provided plug does not fit into your outlet, consult an electrician for replacement of the obsolete outlet.
- 10) Protect the power cord from being walked on or pinched particularly at plugs, convenience receptacles, and the point where they exit from the apparatus.
- 11) Only use attachments/accessories specified by the manufacturer.
- 12) Use only with a cart, stand, tripod, bracket, or table specified by the manufacturer, or sold with the apparatus. When a cart is used, use caution when moving the cart/apparatus combination to avoid injury from tip-over.
- 13) Unplug this apparatus during lightning storms or when unused for long periods of time.
- 14) Refer all servicing to qualified service personnel. Servicing is required when the apparatus has been damaged in any way, such as power-supply cord or plug is damaged, liquid has been spilled or objects have fallen into the apparatus, the apparatus has been exposed to rain or moisture, does not operate normally, or has been dropped.



Safety precautions

FCC Notice

Warning:

This device complies with Part 15 of the FCC Rules. Operation is subject to the following two conditions: (1) This device may not cause harmful interference, and (2) this device must accept any interference received, including interference that may cause undesired operation.

Caution:

You are cautioned that any changes or modifications not expressly approved in this manual could void your authority to operate this equipment.

Note:

This equipment has been tested and found to comply with the limits for a Class B digital device, pursuant to part 15 of the FCC Rules. These limits are designed to provide reasonable protection against harmful interference in a residential installation. This equipment generates, uses and can radiate radio frequency energy and, if not installed and used in accordance with the instructions, may cause harmful interference to radio communications. However, there is no guarantee that interference will not occur in a particular installation. If this equipment does cause harmful interference to radio or television reception, which can be determined by turning the equipment off and on, the user is encouraged to try to correct the interference by one or more of the following measures:

- Reorient or relocate the receiving antenna.
- Increase the separation between the equipment and receiver.
- Connect the equipment into an outlet on a circuit different from that to which the receiver is connected.
- Consult the dealer or an experienced radio/TV technician for help.

Contact:

Responsible Company: Audio-Technica U.S., Inc.
Address: 1221 Commerce Drive, Stow, Ohio 44224, USA
Tel: 330-686-2600

For customers in Canada

IC statement

CAN ICES-3 (B)/NMB-3 (B)

Notes on use

- When using the product, also read the user manuals supplied with the devices that are to be connected.
- When not using the product, remove the power plug from the power outlet.
- Turn the product off before connecting or disconnecting cables.
- If you use the product near a TV or radio antenna, noise may be generated in the TV or radio. In this case, move the product away from the TV or radio antenna.

Maintenance

- If the product becomes dirty or dusty, disconnect the power cable first, and then wipe the product off with a dry soft cloth.
- Do not use benzine, thinner, contact restoring protective agent, or any other chemical agent. Doing so may cause deformation, damage, or malfunction.
- When storing the product for an extended period of time, wrap it with a plastic cover, and do not allow it to be exposed to humidity.

Features

Features of ATDM-1012/ATDM-1012DAN

- Equipped with a 22-input × 12-bus full-matrix mixer that includes 8 sub-input channels
- 10 Mic/Line inputs including a discrete microphone preamplifier with high-quality sound (stereo linking possible for channels 7/8 and 9/10)
- Up to two ES954 hanging-array microphones (sold separately) can be connected via the Mic inputs
- 8 balanced outputs with BTL circuits
- 2 unbalanced stereo outputs that allow output at Mic level
- USB audio I/O (1 stereo input and 1 stereo output)
- Equipped with an independent, 4-group SmartMixer that allows for a selection between gain sharing and gate modes
- Equipped with an echo canceler (with up to 10 Mic inputs) and a noise canceler that can be used simultaneously
- Includes a 4-band EQ (only Low Cut for sub-inputs) for each input channel, and a 12-band EQ for each output channel
- Equipped with 10 compressors/DeEssers and eight 8-band feedback suppressors capable of insertion into each I/O channel
- Includes a ducker for insertion into the 2 unbalanced stereo inputs
- Limiters equipped for each output channel
- Includes an oscillator function convenient for checking the audio of each output channel
- Audio input/output settings can be configured on the front panel, whereas the advanced settings can be configured on a computer using Web Remote.
- Allows for external control with IP Remote Protocol
- A Dante-equipped model (ATDM-1012DAN) is available

About Audio-Technica LINK

Up to eight ATDM-1012 model mixers can be daisy-chained so that, as a whole system, it can handle audio inputs from 80 Mic/Line channels and 16 unbalanced stereo channels. The proprietary Audio-Technica LINK functionality enables the transmission of low-latency, high-speed audio bus signals between devices, making it possible to steadily control and transmit uncompressed audio signals. Furthermore, the model offers excellent workability as it conforms to the Ethernet standards and can be connected to generic LAN cables (shielded cables of Cat5e or above with the conductor diameter size of 24 AWG or larger must be used).

System installation

Installing on a rack

- When installing the product on a rack, make sure that the temperature inside the rack does not reach or exceed 40°C (104°F). Higher temperatures may negatively affect the internal parts of the product, causing the product to malfunction.
- Ensure at least a 10-centimeter (3.94") space between the product and other devices or the top, side, and back faces of the rack.
- The required rack specifications are as follows:
 - EIA-standard 19-inch rack
 - 1U-size attachable rack
 - Rack with a shelf on which the product is placed or a guide rail that supports the product

System installation

Unbalanced connection

An unbalanced connection tends to be subject to induction noise caused by the chassis potential differences. Be sure to match the chassis potentials between devices.

- Match the power supply phases between devices.
- Standardize the power supply systems.
- Connect the GND (ground) terminal or chassis of each device.

Power cable connection

- Connect the power plug to the appropriate outlet with protective grounding. Electric shock may result if the plug is not grounded securely.

How to connect a Euroblock connector

1. As shown in the figure, expose the wires inside the cable.
 - Do not solder the stranded wires.

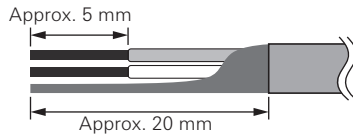

2. Loosen the screws with a flathead screwdriver.

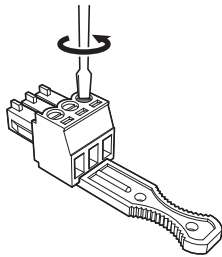

3. Verify the pin assignments, and connect each to the applicable wire.

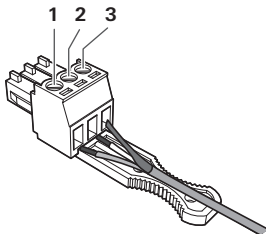

4. Tighten the screws and bundle the wires with a cable tie.

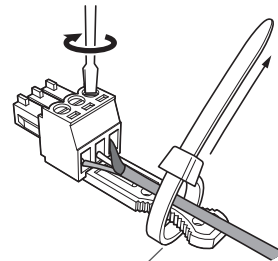

Use any commercially available cable tie.

5. Connect the Euroblock connector to the product.

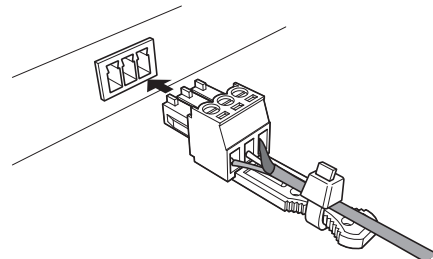

Pin assignments

		1	2	3
INPUT	1 to 10	+: HOT	-: COLD	G: GND
	ST1, ST2	R: RIGHT	L: LEFT	G: GND
OUTPUT	1 to 8	+: HOT	-: COLD	G: GND
	ST1, ST2	R: RIGHT	L: LEFT	G: GND

System connection examples

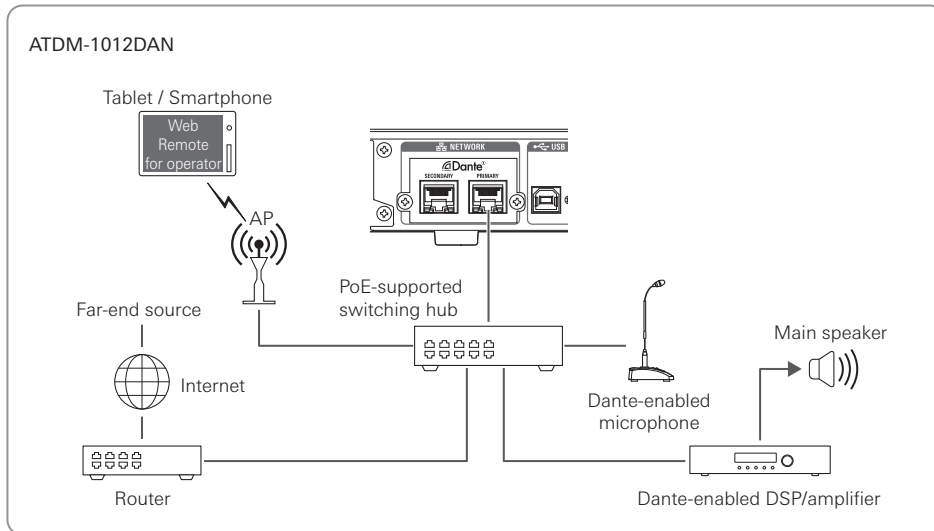
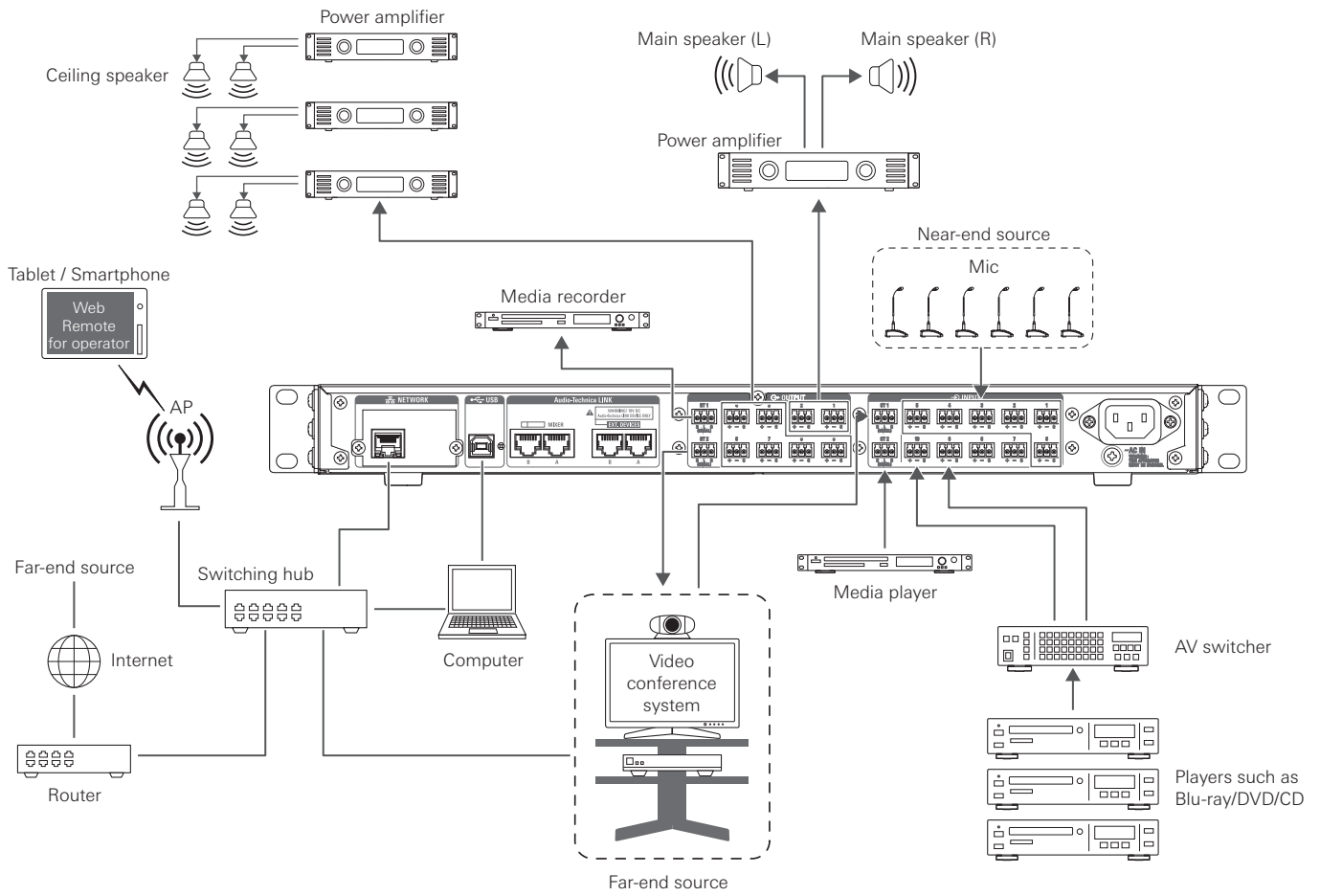

Part names and function

Front Panel

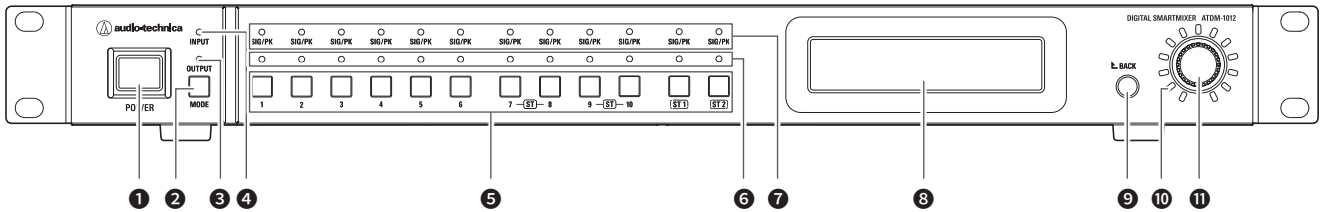

- 1** Power button
Turns on/off the power to the product.
- 2** MODE button
Switches between input/sub input/output channel modes.
- 3** OUTPUT LED
The LED lights in red when in output channel mode.
- 4** INPUT LED
The LED lights in red when in input channel mode.
The LED blinks in red when in sub-input channel mode.
- 5** Channel selection button
Selects an input/output channel or preset number.
- 6** Channel selection LED
Displays the selection status for the input/output channel or preset number.
- 7** SIG/PK LED
Indicates the input signal level.
- 8** Display
- 9** BACK button
Goes back one preceding level or above level.
- 10** Volume LED
Indicates the current setting of the selected channel when the level or gain is being adjusted.
- 11** Dial button
Turn the dial button to select, and push to confirm the selection.

- An LED can be in one of five statuses.

- (1) Lit: Indicates that the channel or preset number is selected, that the function is enabled, etc.
- (2) Off: Indicates that the channel or preset number is not selected, that the function is not enabled, etc.
- (3) Blinking: Indicates that the channel or present number is being selected. Repeats every 500 ms until the status changes.
- (4) Blinking fast: Indicates that the operation has been rejected. Repeats blinking three times every 200 ms.
- (5) Dimmer lit: Indicates lower brightness.

- The signal level ranges indicated by the SIG/PK LEDs are as follows.

- LED lit (red): 0 dBFS to -5 dBFS
- LED lit (yellow): -6dBFS to -24 dBFS
- LED lit (green): -25 dBFS to -59 dBFS
- LED off: -60 dBFS or less

Part names and function

Rear panel

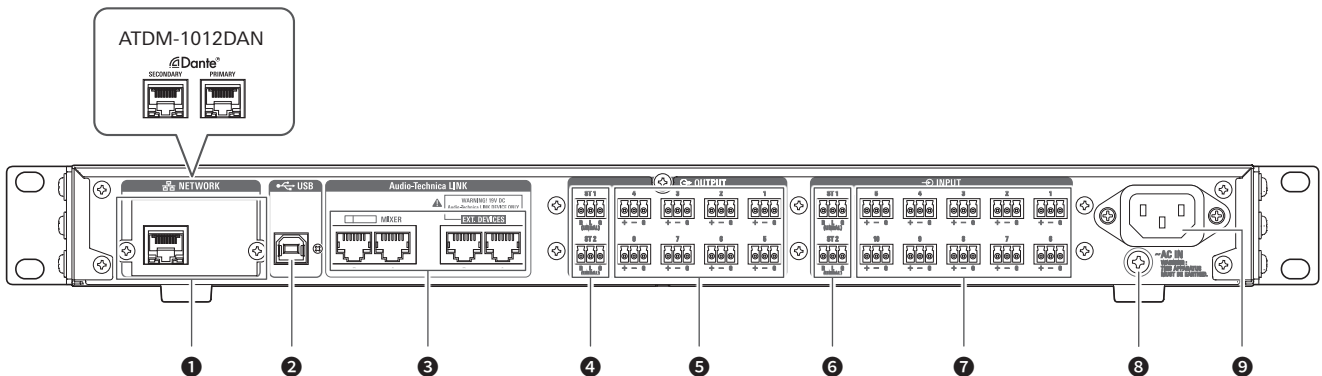

1 Network port/Dante network port (ATDM-1012DAN)

- A NETWORK port. Connect an Ethernet cable (Cat5e or above). Connect to a local area network to control externally via web remote or IP control.
- Connect to the Dante network port to connect to the Dante audio network and control externally via web remote or IP control.
- Details for the PRIMARY port and SECONDARY port depending on the port mode setting are as shown in the table below.

Mode	Connection device	
	PRIMARY	SECONDARY
Switched (Default)	Dante network Web Remote/External control	Dante network Web Remote/External control
Redundant	Dante network (Primary) Web Remote/External control	Dante network (Secondary)
Split	Web Remote/External control	Dante network

2 USB port

A USB port (USB Type-B). Connect a USB cable (with ferrite core).

3 Audio-Technica LINK A/B/C/D ports

Ports for LINK A/B/C/D. Used for Audio-Technica LINK. Connect an Ethernet cable (shielded cable of Cat5e or above with the conductor diameter size of 24 AWG or larger must be used).

4 Unbalanced output port (ST1, ST2)

An unbalanced output port. Connect an unbalanced cable.

Pin assignments are as follows. R: STEREO R, L: STEREO L, G: GND.

5 Balanced output port (1 to 8)

A balanced output port. Connect a balanced cable.

Pin assignments are as follows. +: HOT, -: COLD, G: GND.

6 Unbalanced input port (ST1, ST2)

An unbalanced input port. Connect an unbalanced cable.

Pin assignments are as follows. R: STEREO R, L: STEREO L, G: GND.

7 Balanced input port (1 to 10)

A balanced input port. Connect a balanced cable.

Pin assignments are as follows. +: HOT, -: COLD, G: GND.

8 Grounding screws

The supplied power cable is a 2-core cable, and cannot be used for grounding. Ground the product as necessary.

9 AC inlet

Connect the power cable.

About Dante (ATDM-1012DAN only)

ATDM-1012DAN supports Dante network audio.

ATDM-1012DAN audio can be output to a Dante device or audio from a Dante device can be input to ATDM-1012DAN.

For more details on Dante network audio, refer to the Audinate website at www.audinate.com.

Network port mode settings

Performing settings from the ATDM-1012DAN unit

1. Turn the dial button on the Home screen to select "Set" and then press the dial button.
2. Turn the dial button to select "System Setting" and then press the dial button.
3. Turn the dial button to select "IP Setting" and then press the dial button.
4. Turn the dial button to select "IP Port Set." and then press the dial button.
5. Turn the dial button to select "IP Config Mode" and then press the dial button.
6. Turn the dial button to select "Auto"/"Static" and then press the dial button.
7. Press the power button to restart the product.

Performing settings via Web Remote

Refer to "Network in System Settings"(P.48).

- Settings can also be changed via the Dante Controller (application from Audinate). For information on the Dante Controller, refer to the Audinate website at www.audinate.com.

About Dante (ATDM-1012DAN only)

Connections in each mode

Switched (Default setting)

- The switching hub used for the Dante network must be gigabit-capable. Refer to the Audinate website and other information for required switching hub specifications.
- Connect external controls for Dante audio and the ATDM-1012DAN to either the PRIMARY or SECONDARY port. As shown in the figure, a computer or Dante device can be connected directly to the Dante network port of ATDM-1012DAN.

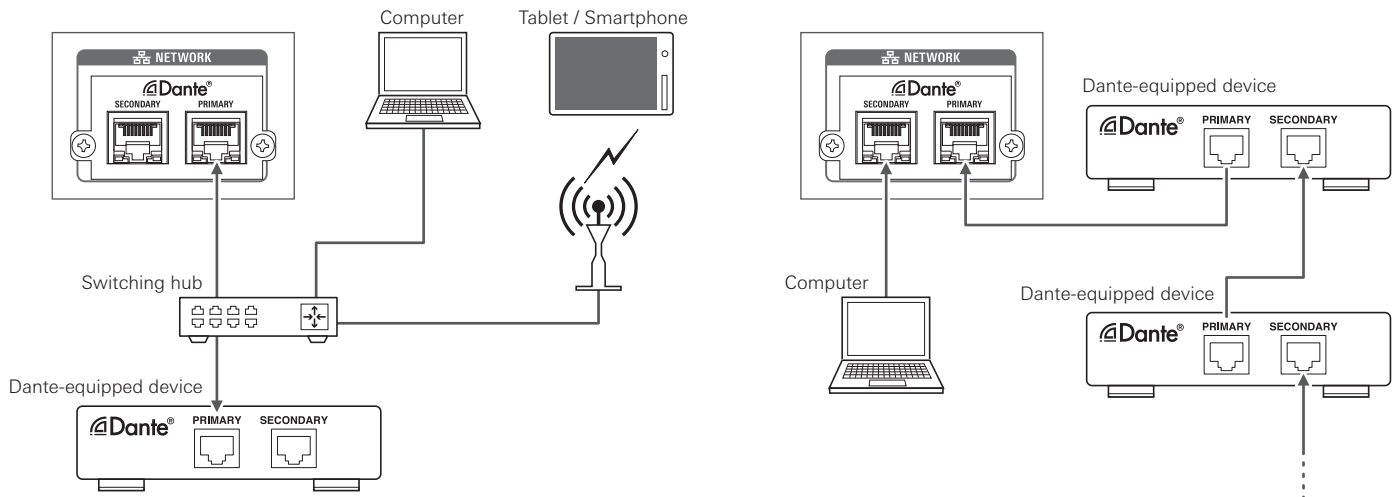

Redundant Audio

In Redundant Audio mode, independent networks are necessary for both PRIMARY and SECONDARY. If an error occurs on the Dante PRIMARY-side network for any reason, it will automatically switch to the Dante audio on the SECONDARY network.

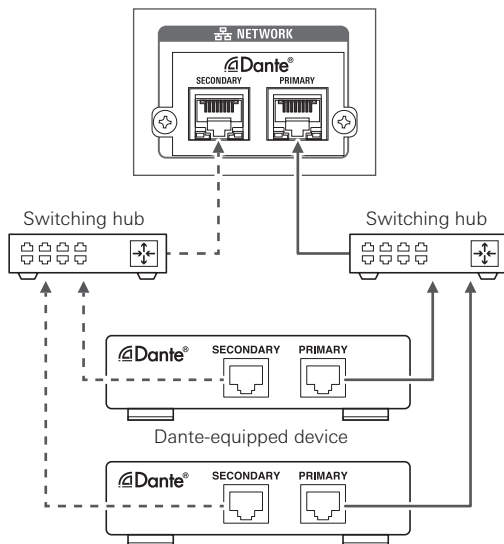

About Dante (ATDM-1012DAN only)

Split

In Split mode, independent networks are necessary for both PRIMARY and SECONDARY. PRIMARY is the ATDM-1012DAN external control port and SECONDARY is the Dante audio port.

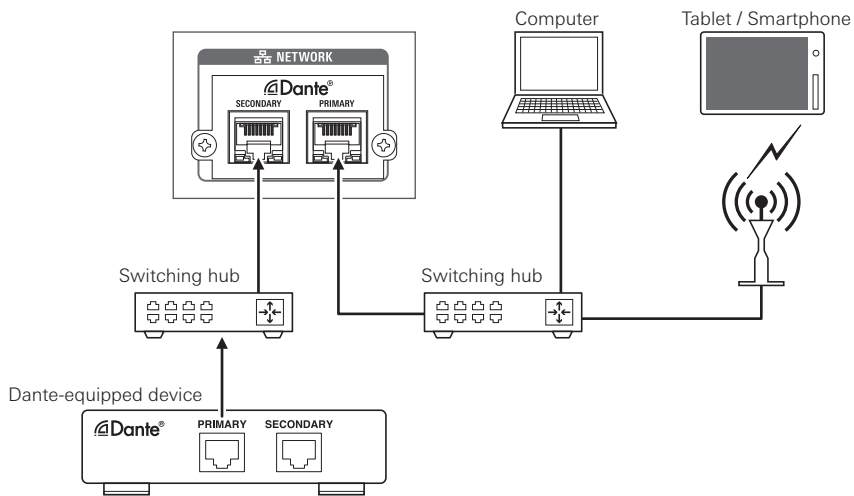

Dante channel list

No	Dante send channels	Dante receive channels
1	BUS1	IN1
2	BUS2	IN2
3	BUS3	IN3
4	BUS4	IN4
5	BUS5	IN5
6	BUS6	IN6
7	BUS7	IN7
8	BUS8	IN8
9	BUS9	IN9
10	BUS10	IN10
11	BUS11	IN11
12	BUS12	IN12
13	Direct Output1	IN13
14	Direct Output2	IN14
15	Direct Output3	IN15
16	Direct Output4	IN16
17	Direct Output5	-
18	Direct Output6	-
19	Direct Output7	-
20	Direct Output8	-
21	Direct Output9	-
22	Direct Output10	-

Basic operations of the product

Starting the product

1. Press the power button.

- The product boots in administrator mode by factory default.

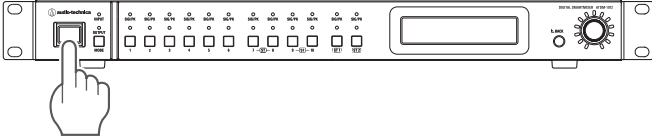

How to view the screens

Administrator mode



Operator mode



- ❶ Audio settings menu
- ❷ Preset settings menu
- ❸ System settings menu
- ❹ I/O channel level adjustment menu

How to input characters

Follow the procedure below to input text.

1. Turn the dial to select which character to input.

- The following characters can be input.

Password	A to Z, a to z, 1 to 9, 0
Device Name	A to Z, a to z, 1 to 9, 0, ! # \$ ' () * + , - . : ; < = > ? @ ` , . (space)
Filename Prefix	A to Z, a to z, 1 to 9, 0, ! # \$ ' () + , - . ; = ? @ ` , . (space)

2. Press the dial button to confirm the character.

- The cursor will then move to the next cell.

3. Continue inputting characters by repeating steps 1 and 2.

- Use the following procedure to edit characters that have been input.

- To move cursor to the character to be edited:

- (1) Turn the dial button while pressing the BACK button to move the cursor.

- (2) Release the BACK button.

- To delete character that has been input:

- (1) Move the cursor to the character to be deleted.

- (2) While pressing the BACK button, press the dial button.

- The character at the cursor location will be deleted.

- If the cursor is at the end of the text and the “_” is blinking, the character immediately before the cursor is deleted.

- To finish editing:

- (1) Press the control button when the cursor is blinking “■”.

- Editing will finish, the cursor will move to the end of the text, and “_” will blink.

4. When the cursor is blinking “_”, press the control button to confirm the text.

- The text will be shown after “Completed!” is displayed.

Basic operations of the product

Front panel mode

The following two modes are available when operating the product with the buttons and the dial on the front panel.

Operator mode:

In this mode, daily operations are performed, such as loading the preset settings and adjusting the audio level.

Administrator mode:

In this mode, advanced settings can be configured by installing and implementing the product on-site.

Changing the front panel mode (operator mode/administrator mode)

1. While pressing the MODE button, press and hold the dial button (for 1 or more seconds).

- The front panel mode changes with every press.

Operator mode	"LVI" is displayed.
Administrator mode	"Aud" is displayed.

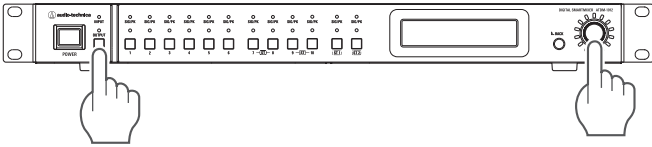

Locking the front panel

A lock can be applied so that the front panel operation is disabled.

1. Press and hold the dial button and BACK button (for 1 or more seconds).

- The front panel becomes locked. Performing the same operation again will unlock the front panel.

Operations that can be performed in operator mode

Adjusting the input and output levels

Adjust the input and output levels for each I/O channel.

1. Turn the dial button on the Home screen to select “Lvl” and then press the dial button.
2. Turn the dial button to select the input or output channel to be adjusted and then press the dial button.
 - The input or output channel to be adjusted can also be selected using the channel selection button.
3. Turn the dial button to select “Level” and then press the dial button.
4. Turn the dial button to adjust the input and output levels.
 - The volume LED becomes lit/turns off based on the adjusting operation.

Turning the mute ON/OFF

Set each of the I/O channels to mute.

1. Turn the dial button on the Home screen to select “Lvl” and then press the dial button.
2. Turn the dial button to select the input or output channel to be set and then press the dial button.
 - The input or output channel to be adjusted can also be selected using the channel selection button.
3. Turn the dial button to select “Mute” and then press the dial button.
4. Turn the dial button to set the mute for the channel ON or OFF.

Recalling Preset

Recall saved preset data to change the current setting.

1. Turn the dial button on the Home screen to select “Pst” and then press the dial button.
2. Turn the dial button to select “Recall Presets” and then press the dial button.
3. Select the preset to be recalled and press the dial button.
 - Presets can also be selected using the channel selection button.
4. Press the dial button.
 - The preset data is read and the settings change.

Confirming product setting statuses

Product setting statuses can be confirmed when in operator mode. To change settings, switch to administrator mode.

1. Turn the dial button on the Home screen to select “Set” and then press the dial button.
2. Turn the dial button to select “System Info” and then press the dial button.
3. Select an item and press the dial button.

Device Name	The name of this product is displayed.
Device ID	The ID number of this product is displayed.
Serial Number	The serial number is displayed.
FW Version	The firmware version is displayed.
IP Config Mode	Settings for obtaining the IP address are displayed.
IP Address	The IP address is displayed.
Subnet Mask	The subnet mask is displayed.
Gateway Address	The gateway address is displayed.
Mac Address	The MAC address is displayed.
Dante*	Information regarding Dante is displayed.
Allow Discovery	The settings for automatic discovery by “Locate” are displayed.
IP Ctrl Port No	The port number of the IP control is displayed.
IP Ctrl Ntfy	Settings for receiving notifications from IP-controlled devices are displayed.
Audio Level Ntfy	Settings for receiving notifications from IP-controlled devices regarding audio levels are displayed.
M-cast Adrs	The address for multicast is displayed.
M-cast Port No	The port number for multicast is displayed.
NTP	Settings for the NTP (Network Time Protocol) are displayed.
NTP Adrs	The NTP server address is displayed.
NTP Port	The NTP port number is displayed.
Time Zone	The time difference from UTC (Coordinated Universal Time) is displayed.
LINK Status	The usage status for Audio-Technica LINK Mode is displayed.
LINK Mode	Whether the product is the primary or an extension during Audio-Technica LINK Mode is displayed.
No.ofExtension A	The number of connected extensions is displayed.
No.ofExtension B	The number of connected extensions is displayed.
No.ofExtension C	The number of connected extensions is displayed.
No.ofExtension D	The number of connected extensions is displayed.

* Displayed only for ATDM-1012DAN.

Operations that can be performed in administrator mode

Audio menu (Aud)

Channel settings (Channel Setting)

Set parameters for each channel.

1. Turn the dial button on the Home screen to select "Aud" and then press the dial button.
2. Turn the dial button to select "Channel Setting" and then press the dial button.
3. Turn the dial button to select the channel to be adjusted and then press the dial button.
4. Turn the dial button to select a function and then press the dial button.
5. Turn the dial button to set the parameters for each function.

- Functions that can be set are as follows.

Source	Sets the source.
Unity	Sets the unity level.
Gain* ¹	Adjusts the gain.
Phantom* ¹	Turns the phantom power ON/OFF.
Phase* ¹	Invert the input audio phase.
Low Cut* ¹	Specify whether or not to remove low frequencies from the audio signal.
FBS* ¹ * ² * ³	Turns the FBS ON/OFF.
EQ	Turns the EQ ON/OFF.
Comp Insrt* ³ * ⁴	Sets whether to take the compressor from the front of the fader (pre-fader) or from the rear (post-fader).
Comp* ⁴	Turns the compressor/DeEsser ON/OFF.
SM Group* ⁵	Sets the Smart Mix group.
SM Enable* ⁵	Turns Smart Mix ON/OFF.
Priority* ⁶	Sets the channel priority.
AEC	Turns the AEC ON/OFF.
Level	Sets the I/O level.
Mute	Turns mute ON/OFF.
Limiter* ³ * ⁷	Turns the Limiter ON/OFF.

*1 Displayed when an input channel is selected.

*2 Displayed when an FBS module is assigned.

*3 Displayed when an output channel is selected.

*4 Displayed when a compressor module is assigned.

*5 Displayed when Smart Mix mode is ON.

*6 Displayed when set to gate mode when Smart Mix mode is ON.

*7 Displayed when a Limiter module is assigned.

Matrix Assign (Matrix Assign)

Set which input channel is sent to which bus or which bus draws from which input channel.

1. Turn the dial button on the Home screen to select "Aud" and then press the dial button.
2. Turn the dial button to select "Matrix Assign" and then press the dial button.
3. Turn the dial button to select "Input -> Bus" or "Bus -> Input" and then press the dial button.
4. Turn the dial button to select the I/O channel.
5. Press the channel selection button to set which input channel is assigned to which bus.
 - A white circle (○) indicates Pre Smart Mix, while a black circle (●) indicates Post Smart Mix.

Setting the USB output (USB Out Setting)

Select the USB output bus and set the transmission level.

1. Turn the dial button on the Home screen to select "Aud" and then press the dial button.
2. Turn the dial button to select "USB OUT Setting" and then press the dial button.
3. Turn the dial button to select "OUT1" or "OUT2" and then press the dial button.
4. Turn the dial button to select the bus.
5. Press the BACK button to return the cursor back one place, then turn the dial button to select "Level" and press the dial button.
6. Turn the dial button to set the transmission level.

Setting the AEC (AEC Setting)

Set the AEC (Acoustic Echo Canceled).

1. Turn the dial button on the Home screen to select "Aud" and then press the dial button.
2. Turn the dial button to select "AEC Setting" and then press the dial button.
3. Turn the dial button to select "Off"/"AEC"/"NC".

Operations that can be performed in administrator mode

Setting the oscillator (Oscillator)

The product has an oscillator function on the output channels. This function is convenient for checking the audio during setup or maintenance.

1. Turn the dial button on the Home screen to select "Aud" and then press the dial button.
2. Turn the dial button to select "Oscillator" and then press the dial button.
3. Turn the dial button to select "Output" and then press the dial button.
4. Turn the dial button to set the oscillator function ON/OFF.
5. Press the BACK button to return the cursor back one place, then turn the dial button to select "Wave" and press the dial button.
6. Turn the dial button to set the output waveform.
7. Press the BACK button to return the cursor back one place, then turn the dial button to select "Level" and press the dial button.
8. Turn the dial button to set the output level.
9. Press the BACK button to return the cursor back one place, then turn the dial button to select "Out".
10. Press the channel selection button to set the channel for output.
 - "✓" will be displayed for the set channel.

Preset menu (Pst)

Recalling presets (Recall Presets)

Recall saved preset data to change the current setting.

1. Turn the dial button on the Home screen to select "Pst" and then press the dial button.
2. Turn the dial button to select "Recall Presets" and then press the dial button.
3. Turn the dial button to select the preset data to be recalled (Preset 1 to Preset 8) and then press the dial button.
 - Presets can also be selected using the channel selection button.
4. Press the dial button.
 - The preset data is read and the settings change.

Saving presets (Save Presets)

Save the current settings as a preset.

1. Turn the dial button on the Home screen to select "Pst" and then press the dial button.
2. Turn the dial button to select "Save Presets" and then press the dial button.
3. Turn the dial button to select the save location (Preset 1 to Preset 8) and then press the dial button.
 - Presets can also be selected using the channel selection button.
4. Press the dial button.
 - The preset data is saved to the specified saving location.

Setting boot up presets (BootUp Presets)

Sets the recalling presets when the product boots.

1. Turn the dial button on the Home screen to select "Pst" and then press the dial button.
2. Turn the dial button to select "BootUp Presets" and then press the dial button.
3. Turn the dial button to select "On" and then press the dial button.
4. Select the designated preset (Preset 1 to Preset 8) and then press the dial button.
 - Presets can also be selected using the channel selection button.

Settings menu (Set)

Performing system settings (System Setting)

1. Turn the dial button on the Home screen to select "Set" and then press the dial button.
2. Turn the dial button to select "System Setting" and then press the dial button.
3. Turn the dial button to select the item to be set and then press the dial button.
4. Set each item.
 - Functions that can be set are as follows.

Device Name	Set the product name.
Device ID	Set a unique ID for the product.
LINK Mode	Set the operation mode under Audio-Technica LINK.
Panel Err Notice	Set whether or not to display error codes on the display of this product.
Panel Mode	Set the front panel mode.
Network Config ^{*1}	Config Mode: Set the network configuration mode to suit the environment. Latency: Set the Dante port latency.
IP Setting	IP Port Set.: Set how to obtain IP addresses (Auto <=> Static). Dante Port Set.: Set how to obtain IP addresses for Dante ports (Auto <=> Static). ^{*1}
Allow Discovery	Set the product to be discovered automatically by the "Locate" application.
IP Ctrl Setting	IP Ctrl Port No: The port number of the IP control is displayed. IP Ctrl Ntfy: Receive notifications from IP-controlled devices. Audio Level Ntfy: Receive audio level notifications from IP-controlled devices. ^{*2} M-cast Adrs: Set the address for multicast. ^{*2} M-cast Port No: Set the port number for multicast. ^{*2}
NTP Setting	Set whether to enable or disable the NTP (Network Time Protocol).
Reset All Dflt.	Reset the product to the factory defaults. (The firmware will remain the current version.)

*1 Displayed only for ATDM-1012DAN.

*2 Displayed when "IP Ctrl Ntfy" is set to "On".

Operations that can be performed in administrator mode

Setting system information (System Info)

Product setting statuses can be confirmed.

1. Turn the dial button on the Home screen to select "Set" and then press the dial button.
2. Turn the dial button to select "System Info" and then press the dial button.
3. Select an item and press the dial button.

Device Name	The name of this product is displayed.
Device ID	The ID number of this product is displayed.
Serial Number	The serial number is displayed.
FW Version	The firmware version is displayed.
IP Config Mode	Settings for obtaining the IP address are displayed.
IP Address	The IP address is displayed.
Subnet Mask	The subnet mask is displayed.
Gateway Address	The gateway address is displayed.
Mac Address	The Mac address is displayed.
Dante*	Information regarding Dante is displayed.
Allow Discovery	The settings for automatic discovery by "Locate" are displayed.
IP Ctrl Port No	The port number of the IP control is displayed.
IP Ctrl Ntfy	Settings for receiving notifications from IP-controlled devices are displayed.
Audio Level Ntfy	Settings for receiving notifications from IP-controlled devices regarding audio levels are displayed.
M-cast Adrs	The address for multicast is displayed.
M-cast Port No	The port number for multicast is displayed.
NTP	Settings for the NTP (Network Time Protocol) are displayed.
NTP Adrs	The NTP server address is displayed.
NTP Port	The NTP port number is displayed.
Time Zone	The time difference from UTC (Coordinated Universal Time) is displayed.
LINK Status	The usage status for Audio-Technica LINK Mode is displayed.
LINK Mode	The operation mode for Audio-Technica LINK Mode is displayed.
No.ofExtension A	The number of connected extensions is displayed.
No.ofExtension B	The number of connected extensions is displayed.
No.ofExtension C	The number of connected extensions is displayed.
No.ofExtension D	The number of connected extensions is displayed.

* Displayed only for ATDM-1012DAN.

Performing logging settings (Logging)

Perform log message settings.

1. Turn the dial button on the Home screen to select "Set" and then press the dial button.
2. Turn the dial button to select "Logging" and then press the dial button.
3. Set each item.
 - Functions that can be set are as follows.

Logging	Set whether or not to save log messages.
Destination	Set whether to write log messages to the internal memory or transfer them to the Syslog server.

Performing preset settings (Presets)

1. Turn the dial button on the Home screen to select "Set" and then press the dial button.
2. Turn the dial button to select "Presets" and then press the dial button.
3. Set each item.
 - Functions that can be set are as follows.

Recall Presets	Recall saved preset data to change the current setting.
Save Presets	Save the current settings as a preset.
BootUp Presets	Sets the recalling presets when the product boots.

Web Remote

What Is Web Remote?

Web Remote is a web-based application for controlling this product. With Web Remote, you can remotely perform the following tasks from your Windows PC, Mac, iOS or Android device (hereinafter “control device”).

- Check the status of the product
- Change the various settings of the product

What is “Locate”?

“Locate” is a launcher application for Web Remote. Connect your control device, then activate “Locate”. With “Locate”, you can quickly access Web Remote without entering the IP address assigned to the product.

- You can also launch Web Remote without using “Locate”.

Recommended environment

OS supporting Web Remote and “Locate”

- Microsoft Windows 8.1 or later
- Apple macOS 10.14 Mojave or later
- Android OS 8.0 or later
- iOS 12 or later

Recommended web browsers for Web Remote

- Google Chrome (Windows and Android)
- Mozilla Firefox (Windows)
- Safari (macOS and iOS)

- You can log into Web Remote from up to 3 control devices at the same time. If two different web browsers are running on one control device, Web Remote recognizes access from two control devices.
- To exit Web Remote, make sure to log out first, and then close the web browser screen. If the screen is closed without logging out, the session may continue, and you may remain logged into Web Remote.
- The minimum size of the web remote screen is 1024 x 768 pixels. For the control device, use a large enough display monitor to display the Web Remote screen in the web browser.

Preparing Web Remote

Connect a control device to the product

1. Before connecting a control device to the product, network settings for both devices must be performed.
 - If IP addresses are obtained automatically when connecting
 - (1) Set the product’s IP Config Mode to “Auto”.
 - The product ships from the factory in “Auto” mode.
 - (2) Set the control device’s network settings so that it connects to the network.
 - If static IP addresses are used when connecting
 - (1) Set the product’s IP Config Mode to “Static”.
 - The IP address is set to a static value.
The default value is “192.168.33.102”.

2. Use a wired or wireless connection to connect the control device to the product.
3. Turn on the control device and the product.
 - If IP addresses are obtained automatically when connecting, it may take some time before the IP address is set.

Setting up “Locate”

1. Download the “Locate” installer/application to the control device.
 - For Windows and Mac:
Download from the Audio-Technica website (www.audio-technica.com) for your country or region.
 - For iOS and Android:
Download from the App Store or Google Play.
Upon completion of the download, proceed to Step 4.
2. Double-click “setup.exe” you have downloaded.
 - The Setup Wizard opens.
3. Follow the on-screen instructions to install “Locate”.
 - When installation is complete, the “Locate” icon appears on the desktop.
4. After confirming that the ATDM-1012 is powered up and connected to the same network as the control device, double-click the “Locate” icon.
 - “Locate” launches. All ATDM-1012s connected to the network are automatically detected.
5. Select the ATDM-1012 you want to control via Web Remote, and click “Open”.
 - The Web Remote Login screen appears.

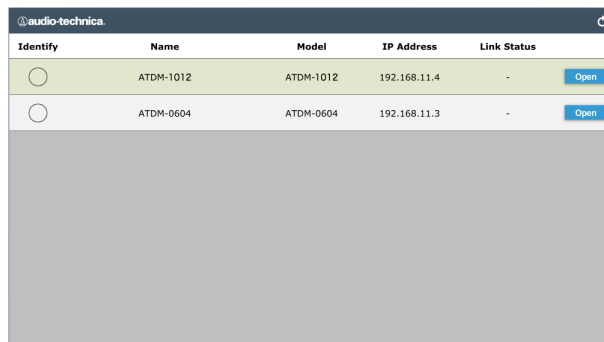

Identify	Name	Model	IP Address	Link Status	
<input type="radio"/>	ATDM-1012	ATDM-1012	192.168.11.4	-	<input type="button" value="Open"/>
<input type="radio"/>	ATDM-0604	ATDM-0604	192.168.11.3	-	<input type="button" value="Open"/>

- When clicking the “Identify” button, the button will illuminate in red, and the indicator lamps on the front panel of the selected ATDM-1012 will blink. Use this function to identify a specific ATDM-1012 in the “Locate” list when multiple ATDM-1012s are connected to the system.

Web Remote

Overview of Web Remote

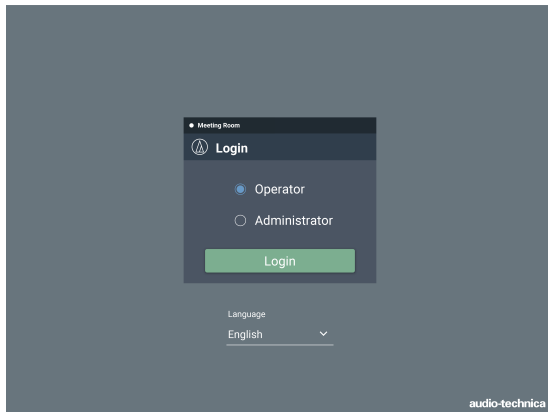

Login screen

Log in as the Operator

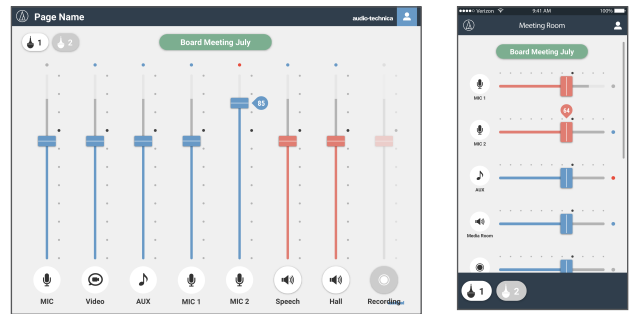

Windows/Mac display

iOS/Android screen

Log in as the Administrator



Audio Settings

- Input:** Set the various options, such as Gain, Level, EQ, and SmartMixer, for audio input from a microphone or other audio devices.
- Matrix:** Set which input channel is sent to which bus or which bus draws from which input channel.
- Output:** Set the various options, such as Level, FBS, EQ, and Dynamics, for audio output.

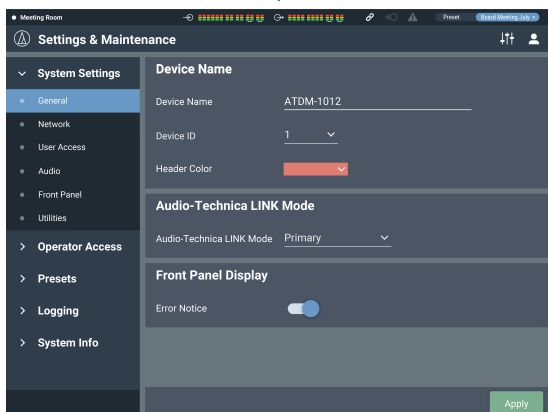

Settings & Maintenance

- System Settings:** Set the options relating to Network, Access Permissions, Audio-Technica LINK, etc., and update the firmware.
- Operator Access:** Set the various options relating to the operation screens you can access after logging in as the Operator.
- Presets:** Recall and save presets and import/export preset data to/from external devices.
- Logging:** Set the options relating to log messages, and download log messages.
- System Info:** Check and download system information, such as the various network settings and the product's serial number and firmware version.

• To log in as the administrator, you must use a Windows PC or a Mac computer. Operations using a tablet or a smartphone are not guaranteed.

Launch/Log into Web Remote

Launching Web Remote

Launching from "Locate"

1. Launch "Locate" you have installed in the control device.
2. From the list, select the ATDM-1012 for which you want to launch Web Remote.
 - Web Remote launches, and the Login screen appears.

Specifying an IP address to launch the Web Remote

If you know the IP address of the product, you can launch Web Remote by specifying the IP address directly.

1. Open the control device's web browser.
2. Enter the IP address of the ATDM-1012 for which you want to launch Web Remote.
 - Web Remote launches, and the Login screen appears.

Login screen

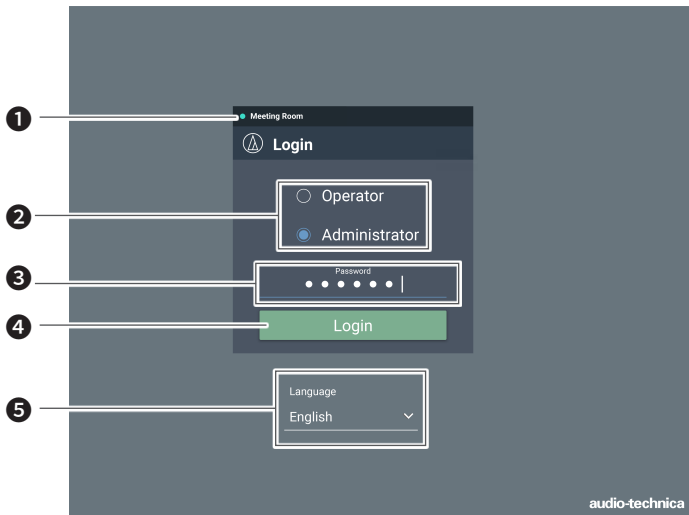

- 1 Device name
The name set for the product is displayed.
- 2 Mode selection
Select "Operator" or "Administrator" as the login user.
- 3 Password
Enter the password.
 - This field appears when login as the Administrator is locked. For the password settings, refer to "Login Password" (P.48).
- 4 Login button
- 5 Language
Select the display language for Web Remote.

Logging into Web Remote

1. Select "Operator" or "Administrator", and then click "Login".
 - If "Administrator" is selected, the password entry field appears. Enter the password, and then click "Login".

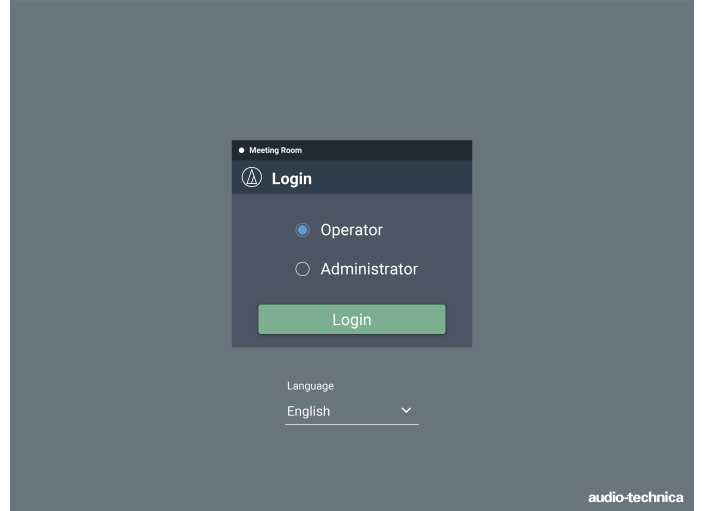

Logging out of Web Remote

1. Click the Logout icon.



2. Click "Log out".
 - Log out of Web Remote.

Operator screen

If you log in as the Operator, you can import the presets, adjust the volumes, and set other options required in day-to-day operations, through simple steps.

Windows/Mac display

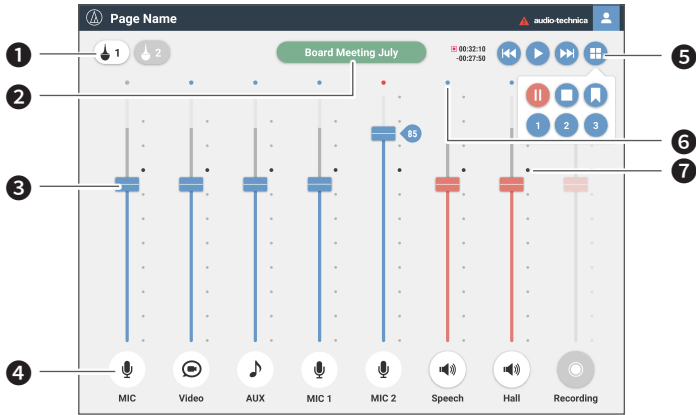

- ❶ Array Mic On/Off
Click to turn on/off the array mic.
- ❷ Preset display
Click to recall a desired preset.
- ❸ Volume adjustment dial
Adjust the volume of each input/output channel.
Blue: Input channel
Red: Output channel
- ❹ Icon/Display name
The icon and display name are displayed as set in "Fader Settings" (P.50). Mute turns ON/OFF each time the icon is clicked.

iOS/Android screen

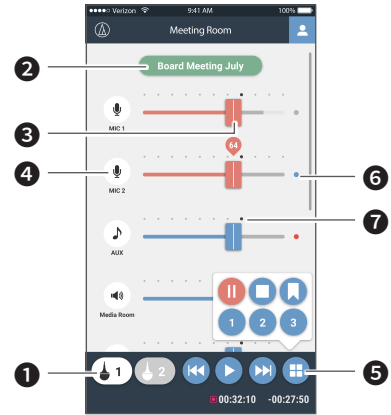

- ❸ Recording operation
Recording operations can be performed by linking with the TASCAM solid-state recorder "SS-R250N".
- ❹ Level meter
The level of each channel is displayed.
 - Input channel:
Blue: Input received
Gray: No input
 - Output channel:
Blue: Level between -6 to -59 dBFS
Red: Level equal to or greater than -5 dBFS
Gray: No input
- ❺ Reference point
The balance is set as adjusted on the Audio Input Screen at the reference point (70%).

Administrator screen

Header

If you log in as the Administrator, you can access the input/output Settings and Settings & Maintenance screens. The header at the top remains the same on both screens.

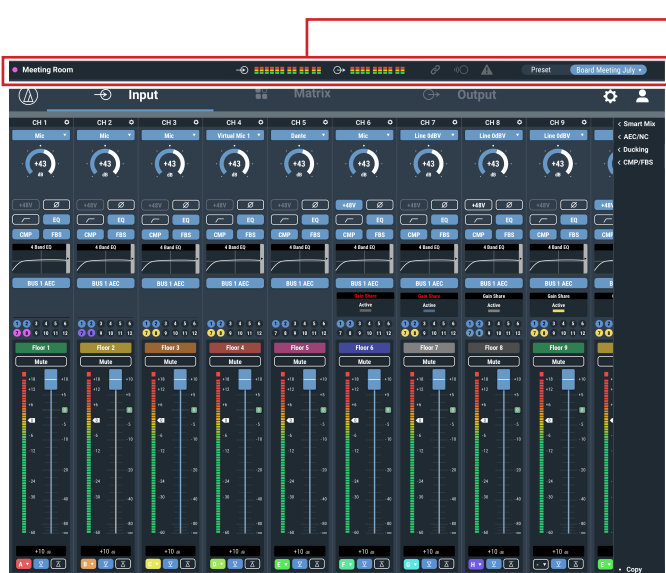

Input Settings

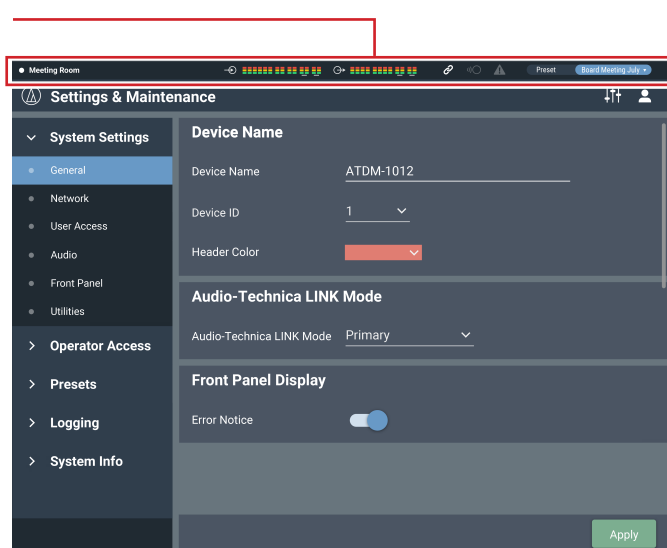











Settings & Maintenance



- 1** Device color
This color helps you identify each device when multiple products are operated.
- 2** Device name
The name set for the product is displayed.
- 3** Input indicator lamp
The input level is displayed.
- 4** Output indicator lamp
The output level is displayed.
- 5** Audio-Technica LINK status
The Audio-Technica LINK connection status is displayed.
- 6** IP remote status
The active status of IP control is displayed.
- 7** Error status
An error status is displayed.
- 8** Preset
The selected preset and the name of the loaded preset are displayed.

Administrator screen

Indicators

Status	Icon display	Description of each status
Audio-Technica LINK status		The Audio-Technica LINK device is not connected correctly.
		The Audio-Technica LINK device is connected correctly.
		There is an Audio-Technica LINK error.
		
IP remote status		Remote control is disabled.
		Remote control is enabled.
		There is a remote control error.
		
Error status		No error is present.
		An error is present.

Error display

When a triangle mark is displayed on an icon, clicking the icon displays a description of the error. After checking the description of the error, move the cursor away from the icon, and the triangle mark will disappear.



Triangle mark

Administrator screen

How to view audio input and output screens



- 1 Click to view the Web Remote version and the Audio-Technica website.
- 2 Click to toggle between the audio input, matrix and audio output settings screens.
- 3 Click to switch to the Settings & Maintenance screen.
- 4 You can configure the audio input settings for each input channel.
- 5 Click each of these items to display a detailed setting menu.
- 6 You can configure the audio output settings for each output channel.

• You may not be able to set and/or operate functions depending on the settings or the conditions. If applicable, those functions are either grayed out or hidden.

Administrator screen

How to view the Matrix Assign screen



- 1 Set whether Smart Mix is ON/OFF for each channel.
- 2 Set whether AEC is ON/OFF for each channel.
- 3 Select the NC bus.
- 4 Switch the ST LINK for the bus ON/OFF.
- 5 Set which channel is assigned to which bus.

Setting the audio input details

Changing the input type (MIC/LINE)

Specify the input type.

1. Click the area in the red box on the screen shown below.

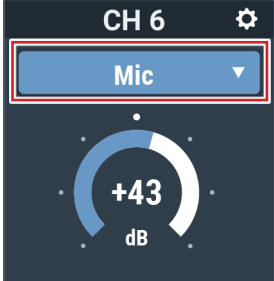

2. Select the input type from the pull-down menu.

- The input type changes.

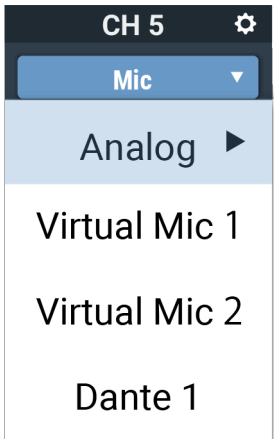

Adjusting the gain

Set the input gain for Mic input.

1. Drag the meter to adjust the gain.

- You can also click the number and enter the gain directly.

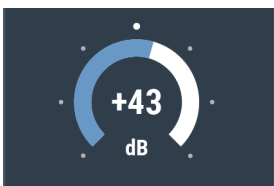

- During input gain adjustment, the level meter turns blue and displays the pre-fader level. Adjust the input gain while monitoring the blue level meter.

Turning the phantom power ON/OFF

Turn ON/OFF the phantom power (+48V). This setting can be made only when "Mic" is selected as the input type.

1. Click the area in the red box on the screen shown below.

- The setting is turned ON (blue)/OFF (no color) each time the switch is clicked.



Turning the phase ON/OFF

Invert the input audio phase.

1. Click the area in the red box on the screen shown below.

- The setting is turned ON (blue)/OFF (no color) each time the switch is clicked.



Turning the low-cut ON/OFF

Specify whether or not to remove low frequencies from the audio signal.

1. Click the area in the red box on the screen shown below.

- The setting is turned ON (blue)/OFF (no color) each time the switch is clicked.



Turning the 4-band EQ ON/OFF

Turn ON/OFF the 4-band EQ to be applied to audio inputs.

1. Click the area in the red box on the screen shown below.

- The setting is turned ON (blue)/OFF (no color) each time the switch is clicked.

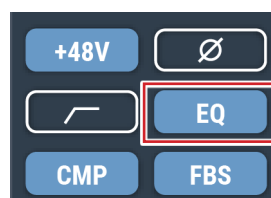

Setting the audio input details

Turning the compressor ON/OFF

Switch the compressor between ON and OFF for each channel. This setting can be made only when the compressor module is assigned.

1. Click "CMP/FBS".



2. Select the check box next to the channel(s) to which it will be assigned.



3. Click the area in the red box on the screen shown below.
 - The setting is turned ON (blue)/OFF (no color) each time the switch is clicked.

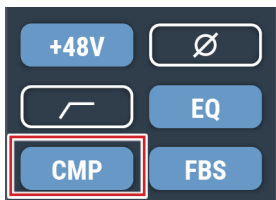

Turning the FBS ON/OFF

Switch the FBS (feedback suppressor) between ON and OFF for each channel. This setting can be made only when the FBS module is assigned.

1. Click "CMP/FBS".



2. Select the check box next to the channel(s) to which it will be assigned.

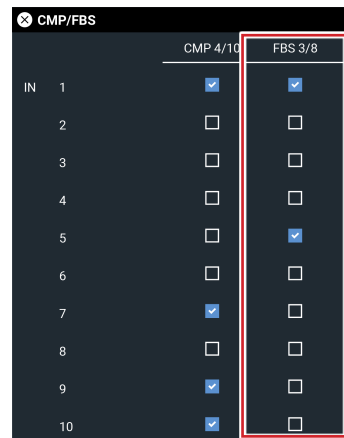

3. Click the area in the red box on the screen shown below.
 - The setting is turned ON (blue)/OFF (no color) each time the switch is clicked.

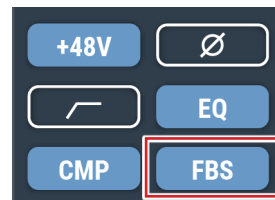

Setting the audio input details

Adjusting the 4-band EQ

Set the 4-band EQ to be applied to audio inputs.

1. Click the area in the red box on the screen shown below.
 - The Settings screen appears.

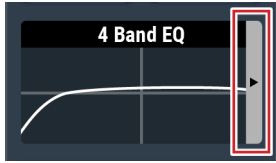

2. Set each item.



Setting the audio input details

How to view settings screen (FBS)

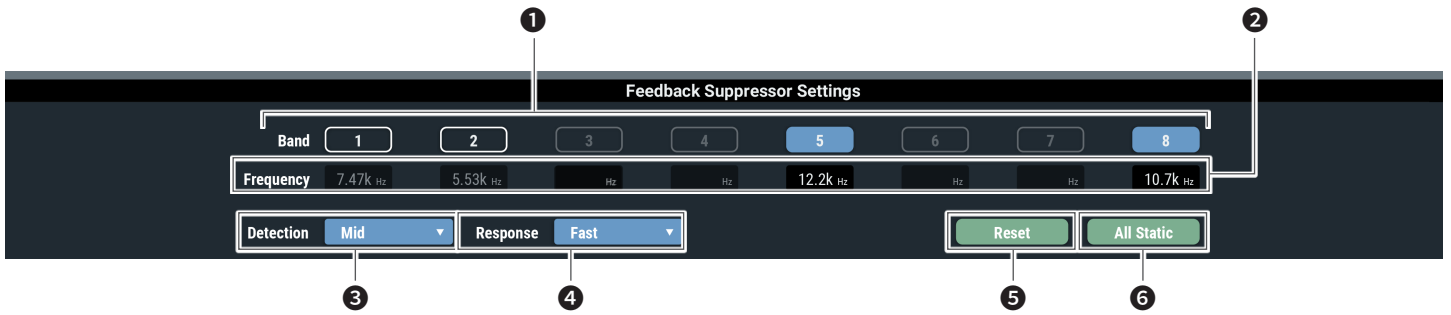

1 The statuses of the bands appear. You can also switch between dynamic and static.

	<p>Dynamic state.</p> <ul style="list-style-type: none"> Indicates that the feedback frequency is detected, and the FBS is functioning. The feedback frequency remains for 15 seconds and is then automatically cleared. Until a new frequency is detected, the feedback frequency display is left blank and turns into a standby state.
	<p>Static state.</p> <ul style="list-style-type: none"> Click this icon in a dynamic state to lock the band and enter a static state. Click the icon again to cancel a static state of the band and enter a standby state.
	<p>Standby state.</p> <ul style="list-style-type: none"> Waiting for a new feedback frequency to be detected.

2 The frequencies of the detected feedbacks appear.

3 Select the strength to suppress the feedback.

4 Select the speed of suppressing the feedback.

5 Click to reset the detected frequencies. Once reset, new frequencies are detected (but those of the bands in a static state are not reset).

6 Set all bands to a static state.

- Switch the settings of "Detection" (3) or "Response" (4) to reset the band frequencies in a dynamic state.

Setting the audio input details

How to view settings screen (EQ)

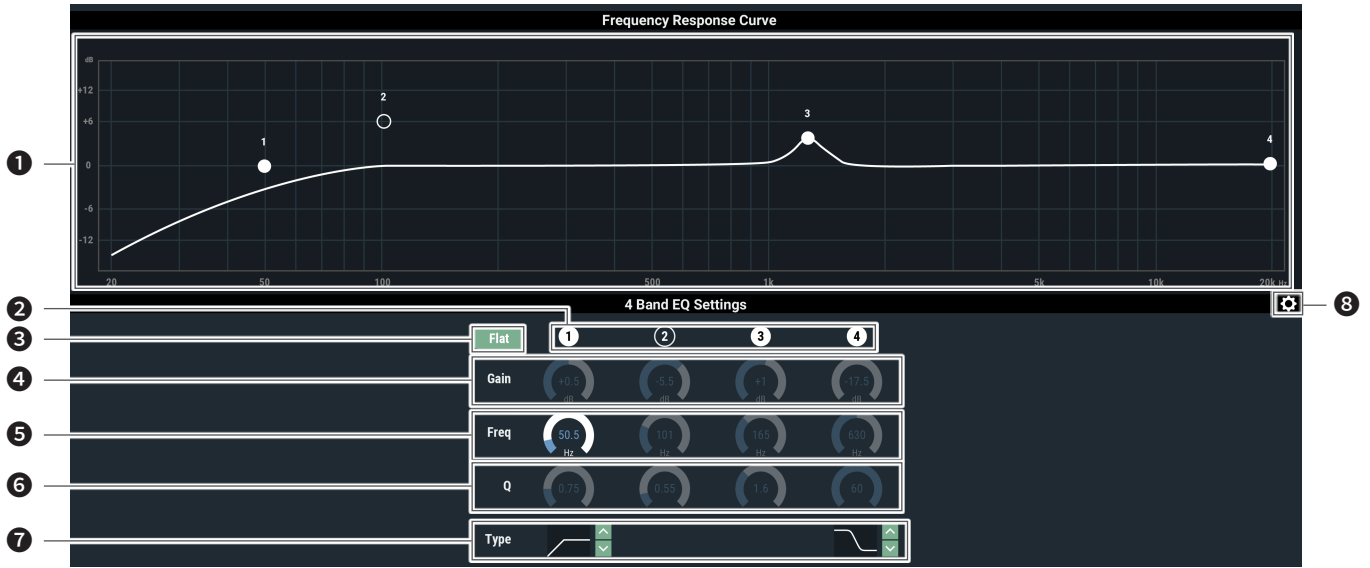

- ❶ Display and edit the EQ frequency response waveform. The pointer for each band indicates the frequency and the gain position.
 - Edit the frequency and the gain by dragging a pointer.
- ❷ Display and switch the ON/OFF setting of each band. The ON and OFF statuses indicate as follows.

- ❸ In all bands, change the gain to 0 without changing the current frequency.
- ❹ Adjust the gain of each band.
- ❺ Adjust the frequency of each band.
- ❻ Adjust the Q value of each band.
- ❼ Change the filter type (applicable to bands 1 and 4 only).
- ❽ Save an EQ preset, reset the EQ frequency response waveform, or switch the setting screen.

❶	Turned ON.
❷	Turned OFF.

Setting the audio input details

Changing settings screen

The Settings screen can be in “Easy Mode” with a simplified display or in “Expert Mode” with all items displayed.

Easy mode	Select from the pre-arranged EQ patterns to easily adjust the EQ.
Expert mode	The parameters can be set for each band for finer EQ adjustment.

Click the icon (⚙️) on the top right of the screen to switch between the two.

How to view settings screen (Easy Mode)

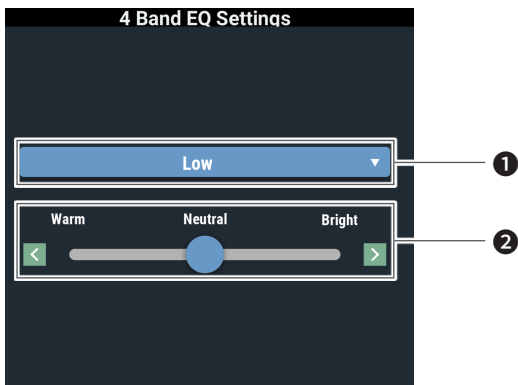

- 1 Select the audio type.
- 2 Adjust the tone.

Setting the audio input details

How to view settings screen (DYN)

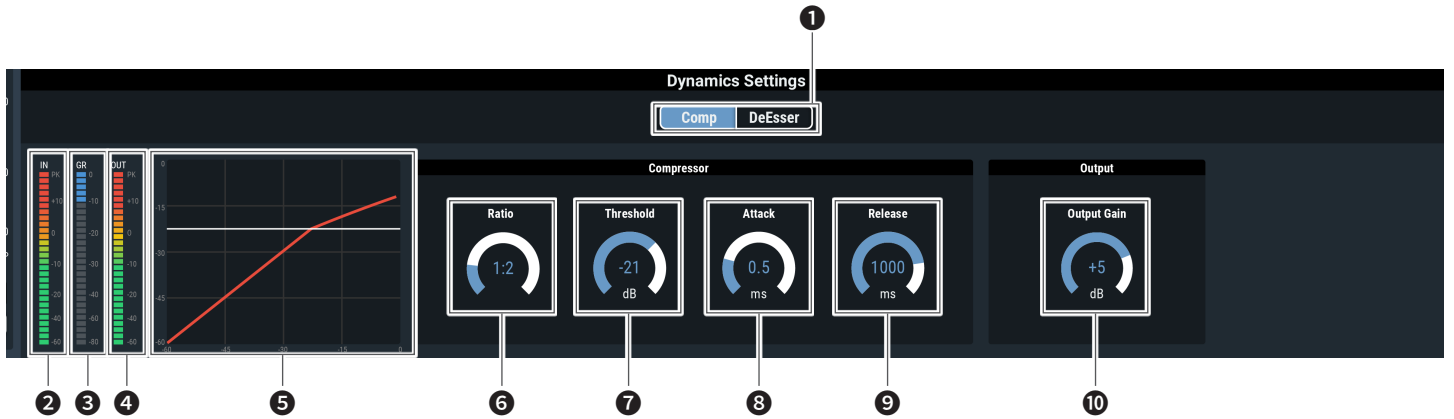

- 1 Switch between the compressor and DeEsser.
- 2 Indicates the level of audio input to Dynamics.
- 3 Indicates the level of audio gain suppression by the compressor.
- 4 Indicates the level of audio output from Dynamics.
- 5 Indicates the Dynamics characteristic.
- 6 Set the compressor ratio.
- 7 Set the compressor threshold.
- 8 Set the compressor attack time.
- 9 Set the compressor release time.
- 10 Set the Dynamics output gain.

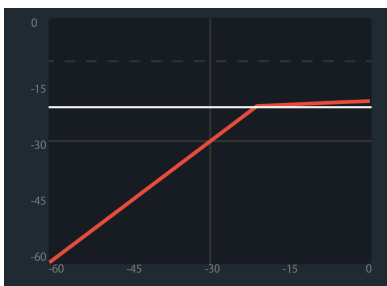
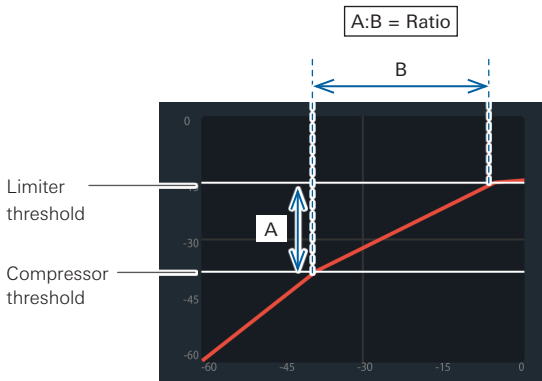

When the limiter threshold is lower than the compressor threshold, the compressor threshold is cleared, and only the limiter threshold is displayed.

Setting the audio input details

Turning the AEC ON/OFF

Turn ON/OFF the AEC (Acoustic Echo Canceler).

1. Click the area in the red box on the screen shown below.
 - The setting is turned ON (blue)/OFF (no color) each time the switch is clicked.



Checking bus assignments

You can check which channels are assigned to which buses.

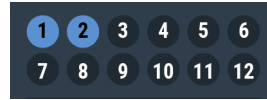

Checking SmartMixer status

1. Check the area in the red box on the screen shown below.
 - Click on the screen to display the SmartMixer Settings screen. For more details, refer to "SmartMixer" (P.57).

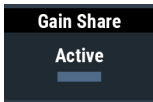
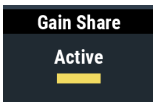

	Turned OFF.
	Turned ON.
	Turned ON, and SmartMixer active. Displayed in the set group color.

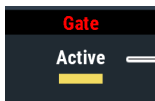

"Priority" is turned ON if "Gate" is displayed in red.

Setting the audio input details

Setting channel names and colors

Set the name and color of each channel.

1. Click the area in the red box on the screen shown below.



2. Select a color of your choice.
3. Click the text input field and enter the channel name of your choice.
4. Click "OK".

Turning the mute ON/OFF

Switch the mute setting between ON and OFF for each channel.

1. Click the area in the red box on the screen shown below.
 - Mute turns ON (red)/OFF (no color) each time the switch is clicked.



Adjusting the input level

Set the Mic/Line input level for each channel.

1. Drag the volume adjustment dial, and move it up and down to adjust the input level.

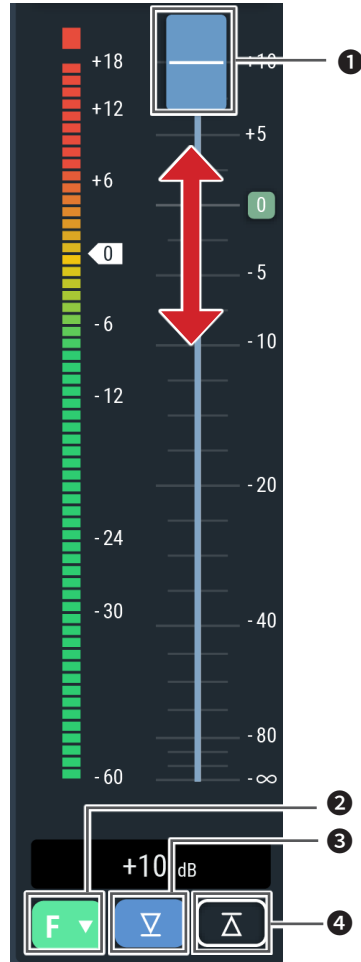

1. Volume adjustment dial
2. Fader group
3. Min Volume ON/OFF
4. Max Volume ON/OFF

Setting the audio input details

Setting the fader group

If the channel faders for the primary and extensions are set to the same group on this screen and assigned in the “Fader Settings” (P.50) on the operator screen for the primary, the levels of channels belonging to the same group will be controlled using the fader assigned to that primary.

1. Click the area in the red box on the screen shown below.



2. Select the fader group.

Setting the Min/Max Volume

Determine the Min/Max Volume and turn it ON/OFF for each channel.

1. Click the area in the red box on the screen shown below.
 - The setting is turned ON (blue)/OFF (no color) each time the switch is clicked.
 - The fader minimum/maximum are set at the position when the Min/Max Volume is turned ON. The range below and above the specified position is grayed out. To change the position, turn the Max Volume OFF and then back ON.



Setting the Matrix details

Setting Smart Mix

1. Select a group by clicking the area in the red box on the screen shown below.

Channel	Smart Mix	AEC
CH 1	G1 ✓	<input type="checkbox"/>
Dante2	G1 ✓	<input type="checkbox"/>
Mic 3	G2 ✓	<input type="checkbox"/>
Music	G2 ✓	<input checked="" type="checkbox"/>

2. Select the check box to turn Smart Mix to ON.

Turning the AEC ON/OFF

Turn ON/OFF the AEC (Acoustic Echo Canceler).

1. Select the check box to turn the AEC to ON.

Channel	Smart Mix	AEC
CH 1	G1 ✓	<input type="checkbox"/>
Dante2	G1 ✓	<input type="checkbox"/>
Mic 3	G2 ✓	<input type="checkbox"/>
Music	G2 ✓	<input checked="" type="checkbox"/>

Selecting the NC bus

1. Click to select the NC bus.

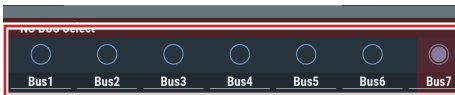

Setting the bus assignment

Select which bus each channel will be assigned to.

Press the button to switch between "OFF", "ON (Smart Mix)", and "ON" in that order. When Smart Mix is "OFF", pressing the button will only switch between "ON" and "OFF".

1. Click the area in the red box on the screen shown below.



Adjusting the volume

Adjust the levels for input to each bus.

1. Adjust the level by dragging a meter.



Setting Mono

If Mono is turned on, the ST CH will be mixed in Mono and can be assigned to each bus. Also, Mono can be turned on and off separately for each link bus.

1. Click the area in the red box on the screen shown below.



Setting bus stereo links

Switch the stereo links ON/OFF for BUS 5/6, BUS 7/8, BUS 9/10 and BUS 11/12.

1. Click the area in the red box on the screen shown below.
 - L-R markings will be displayed for each volume (only channels 7 to 10 and ST channels 1 and 2).



Setting the audio output details

Setting channel outputs

1. Click the area in the red box on the screen shown below.

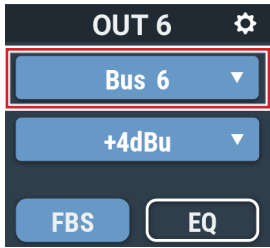

2. Select the output from the pull-down menu.

Setting the unity level

1. Click the area in the red box on the screen shown below.

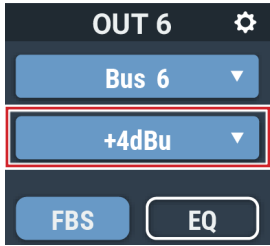

2. Select a unity level from the pull-down menu.

- The unity level changes.

Turning the FBS ON/OFF

Switch the FBS (feedback suppressor) between ON and OFF for each channel. This setting can be made only when the FBS module is assigned. This operation is the same as that for the input channels.

1. Click the area in the red box on the screen shown below.

- The setting is turned ON (blue)/OFF (no color) each time the switch is clicked.

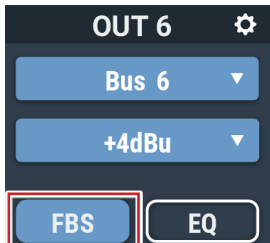

Turning the EQ ON/OFF

Switch the EQ between ON and OFF for each channel.

1. Click the area in the red box on the screen shown below.

- The setting is turned ON (blue)/OFF (no color) each time the switch is clicked.



Adjusting the FBS/EQ

1. Click the area in the red box on the screen shown below.

- The Settings screen appears.

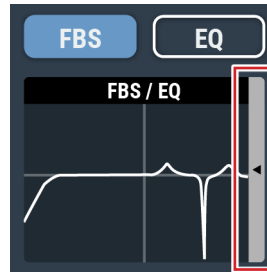

2. Set each item.



Setting the audio output details

How to view settings screen (FBS)

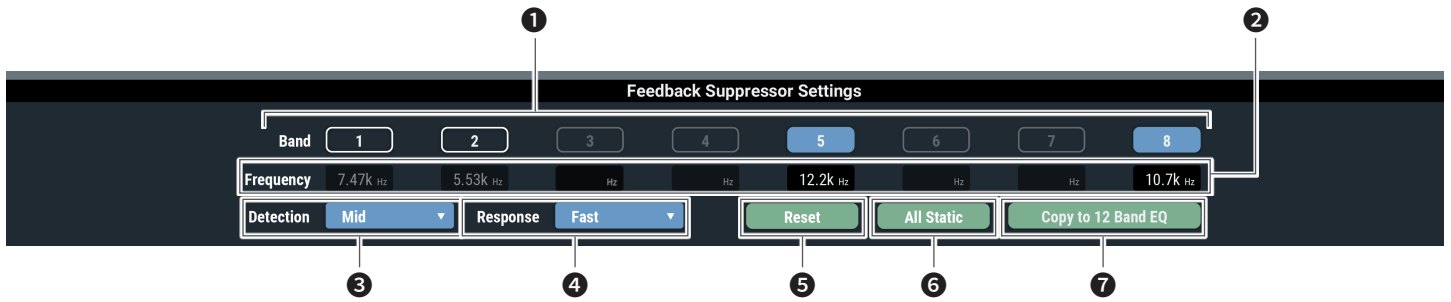

1 The statuses of the bands appear. You can also switch between dynamic and static.

	<p>Dynamic state.</p> <ul style="list-style-type: none"> Indicates that the feedback frequency is detected, and the FBS is functioning. The feedback frequency remains for 15 seconds and is then automatically cleared. Until a new frequency is detected, the feedback frequency display is left blank and turns into a standby state.
	<p>Static state.</p> <ul style="list-style-type: none"> Click this icon in a dynamic state to lock the band and enter a static state. Click the icon again to cancel a static state of the band and enter a standby state.
	<p>Standby state.</p> <ul style="list-style-type: none"> Waiting for a new feedback frequency to be detected.

2 The frequencies of the detected feedbacks appear.

3 Select the strength to suppress the feedback.

4 Select the speed of suppressing the feedback.

5 Click to reset the detected frequencies. Once reset, new frequencies are detected (but those of the bands in a static state are not reset).

6 Set all bands to a static state.

7 Click to copy the static bands to the bands of 12-band EQ. The bands for which the 12-band EQ is turned off are copied.

- Switch the settings of "Detection" (3) or "Response" (4) to reset the band frequencies in a dynamic state.

Setting the audio output details

How to view settings screen (EQ)

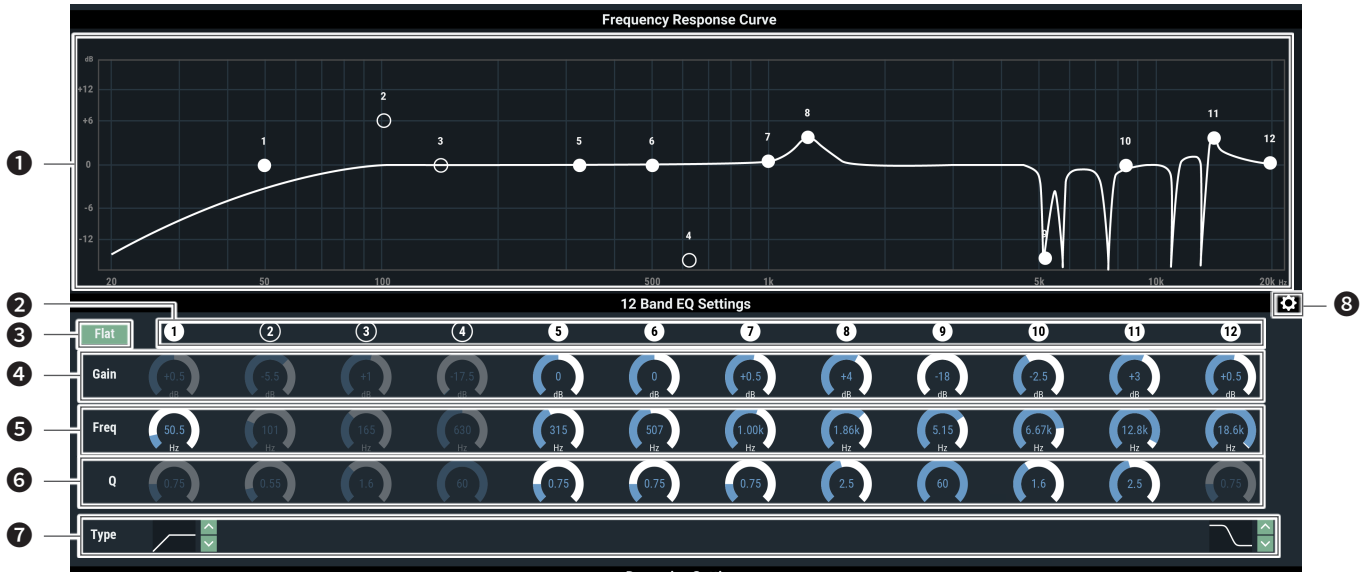

- 1 Display and edit the EQ frequency response waveform. The pointer for each band indicates the frequency and the gain position.
 - Edit the frequency and the gain by dragging a pointer.
- 2 Display and switch the ON/OFF setting of each band. The ON and OFF statuses indicate as follows.
- 3 In all bands, change the gain to 0 without changing the current frequency.
- 4 Adjust the gain of each band.
- 5 Adjust the frequency of each band.
- 6 Adjust the Q value of each band.
- 7 Change the filter type (applicable to bands 1 and 12 only).
- 8 Reset a parameter and save/recall an EQ preset.

1	Turned ON.
2	Turned OFF.

Setting the audio output details

How to view settings screen (DYN)

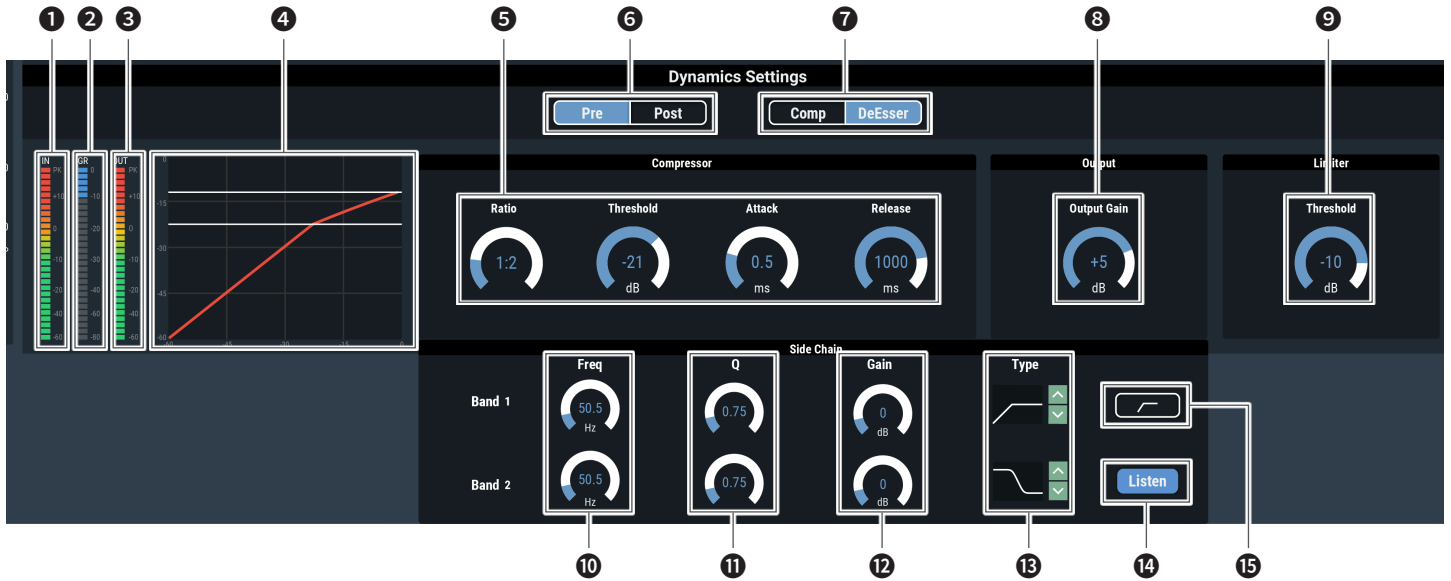

- 1 Indicates the level of audio input to Dynamics.
- 2 Indicates the level of audio gain suppression by the compressor.
- 3 Indicates the level of audio output from Dynamics.
- 4 Indicates the Dynamics characteristic.
- 5 Set each item for the compressor.
Ratio: Set the compressor ratio.
Threshold: Set the compressor threshold.
Attack: Set the compressor attack time.
Release: Set the compressor release time.
- 6 Select whether to assign the Dynamics as Pre EQ or Post EQ.
- 7 Switch between the compressor and DeEsser.
- 8 Set the Dynamics output gain.
- 9 Set the Limiter threshold.
- 10 Adjust the frequency of the DeEsser.
- 11 Adjust the Q value of the DeEsser.
- 12 Adjust the gain of the DeEsser.
- 13 Change the filter type.
- 14 Turn the Listen function ON/OFF.
- 15 Turn the low-cut ON/OFF.

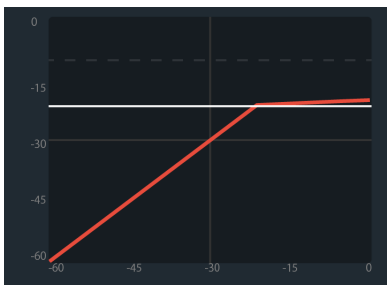
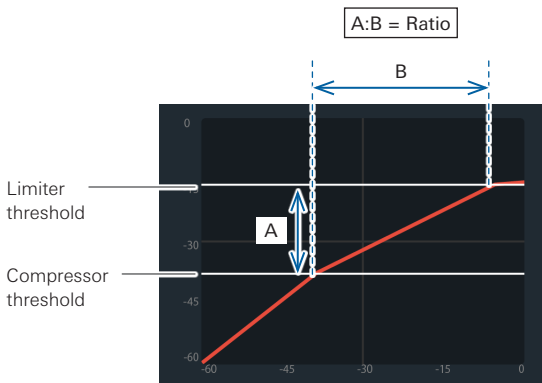

When the limiter threshold is lower than the compressor threshold, the compressor threshold is cleared, and only the limiter threshold is displayed.

Setting the audio output details

Turning the compressor ON/OFF

Switch the compressor between ON and OFF for each channel. This setting can be made only when the compressor module is assigned. This operation is the same as that for the input channels.

- Click the area in the red box on the screen shown below.
 - The setting is turned ON (blue)/OFF (no color) each time the switch is clicked.

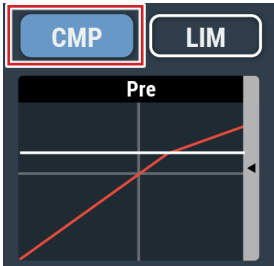

- Click the area in the red box on the screen shown below.
 - The setting is turned ON (blue)/OFF (no color) each time the switch is clicked.

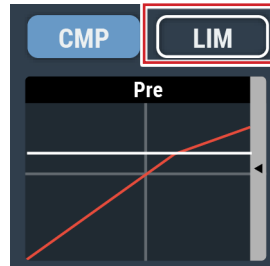

Adjusting the dynamics

- Click the area in the red box on the screen shown below.
 - The Settings screen appears.

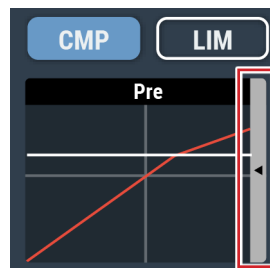

Turning the Limiter ON/OFF

Switch the Limiter between ON and OFF for each channel. This setting can be made only when the Limiter module is assigned.

- Click "Limiter".



- Set each item.

Turning the delay function ON/OFF

Specify whether or not to delay the output of each channel.

- Click the area in the red box on the screen shown below.
 - The setting is turned ON (blue)/OFF (no color) each time the switch is clicked.

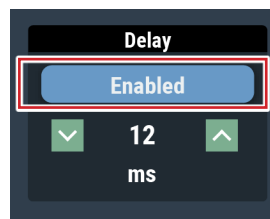

- Select the check box next to the channel(s) to which it will be assigned.

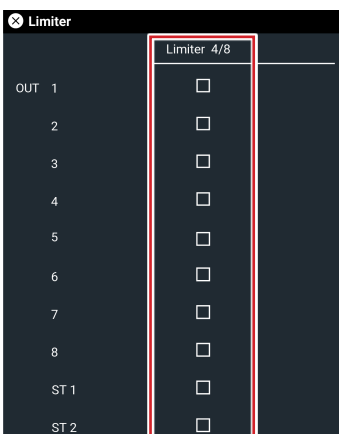

Setting the delay time for delay function

- Set the amount of time to delay.
 - Click / to adjust the time. You can also click the time and enter the value directly.

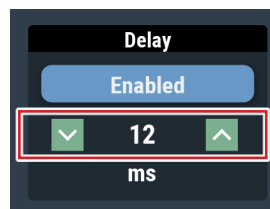

Setting the audio output details

Setting channel names and colors

Set the name and color of each channel.

1. Click the area in the red box on the screen shown below.

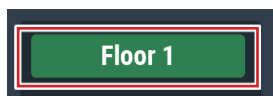

2. Select a color of your choice.
3. Click the text input field and enter the channel name of your choice.
4. Click "OK".

Adjusting the output level

Set the Mic/Line output level for each channel.

1. Click the volume adjustment dial, and move it up and down to adjust the output level.

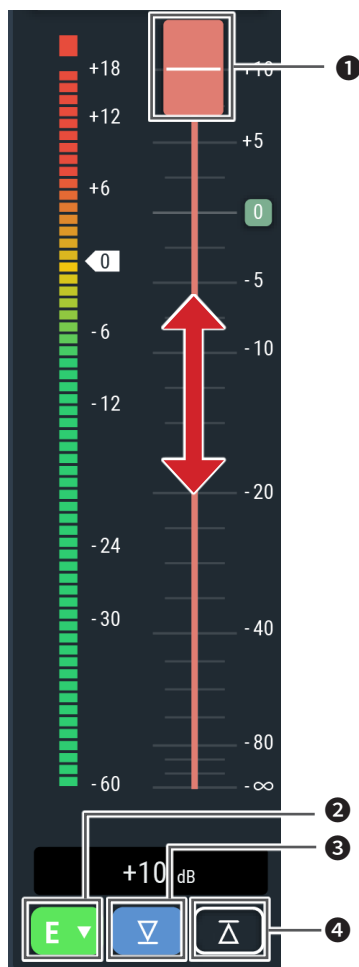

1. Volume adjustment dial
2. Fader group
3. Min Volume ON/OFF
4. Max Volume ON/OFF

Setting the audio output details

Setting the fader group

If the channel faders for the primary and extensions are set to the same group on this screen and assigned in the “Fader Settings” (P.50) on the operator screen for the primary, the levels of channels belonging to the same group will be controlled using the fader assigned to that primary.

1. Click the area in the red box on the screen shown below.



2. Select the fader group.

Setting the Min/Max Volume

Determine the Min/Max Volume and turn it ON/OFF for each channel.

1. Click the area in the red box on the screen shown below.
 - The setting is turned ON (blue)/OFF (no color) each time the switch is clicked.
 - The fader minimum/maximum are set at the position when the Min/Max Volume is turned ON. The range below and above the specified position is grayed out.To change the position, turn the Max Volume OFF and then back ON.



Setting the audio output details

Setting the USB output

Select the USB output bus and set the transmission level.

1. Click "USB OUT".



2. Select the bus for outputs USB OUT1 and 2.

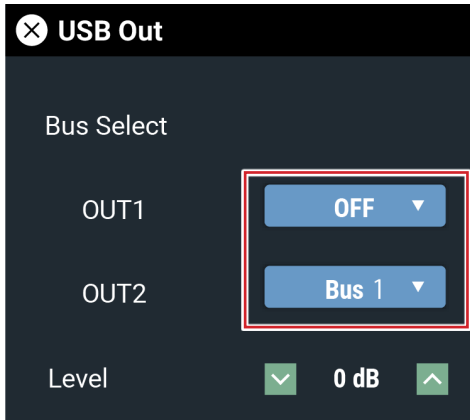

3. Select the level for USB output.

- Click / to adjust the level. You can also click the number and enter another value directly.

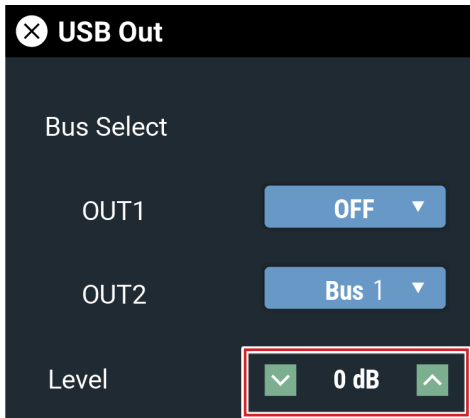

Setting the oscillator

The product has an oscillator function on the output channels. This function is convenient for checking the audio during setup or maintenance.

1. Click "Oscillator".



2. Click "Enable".

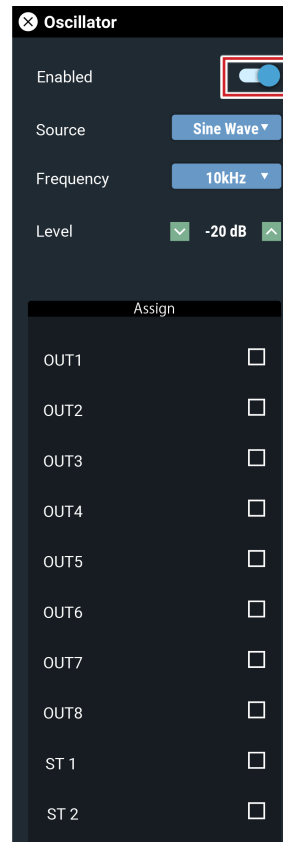

3. Select between "Sine Wave" and "Pink Noise" for the "Source".
4. Select the frequency next to "Frequency".
5. Adjust the level next to "Level".
6. Select the output channels under "Assign".
 - When "Enable" is ON for the selected channels, the oscillator will be activated.

Setting the system details (Settings & Maintenance)

Advanced options for the entire system and access utilities to help maintain and troubleshoot the system are available.

Basic operations

1. Click the icon (⚙️) on the top right of the screen.



2. From the list of setting items, select the item you want to set.

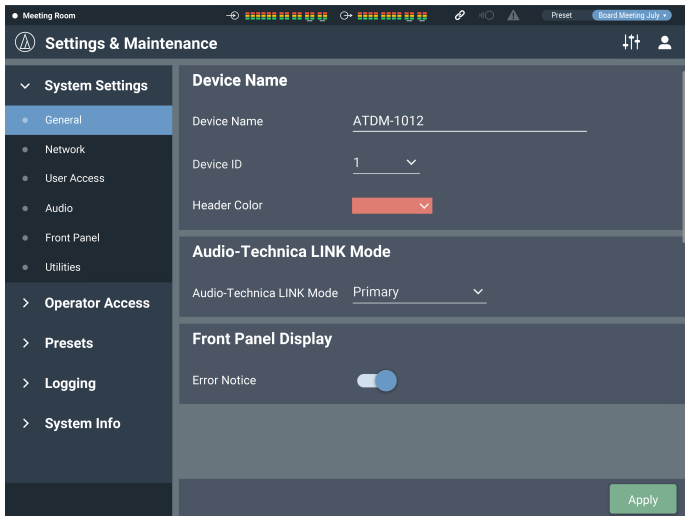

3. Set the item as necessary, and click "Apply".

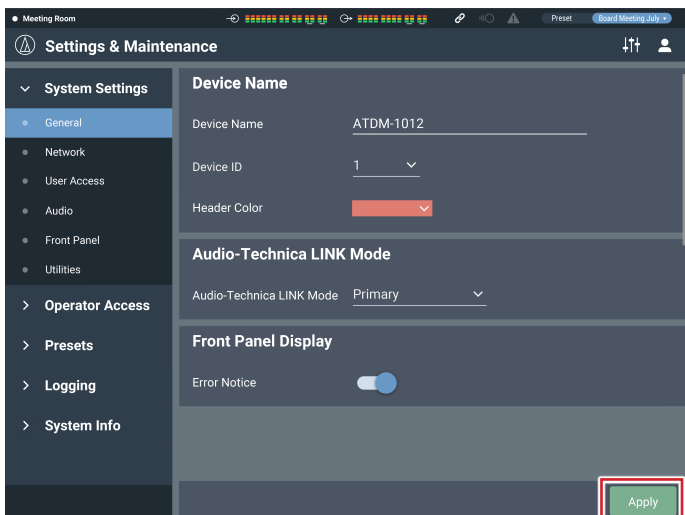

Settings & Maintenance screen

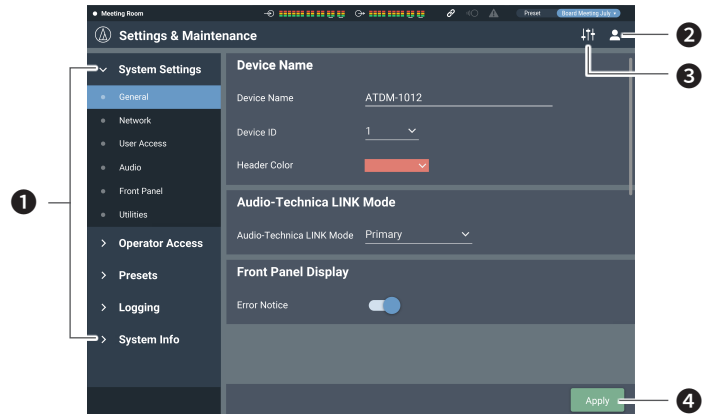

- 1 Setting Items menu
- 2 Log Out icon
- 3 Screen selector icon
The Audio Settings screen appears.
- 4 Apply button
The change made to each setting is reflected.

General in System Settings

Device Name

Device Name	Set the name of the product being controlled from Web Remote.
Device ID	Set the device ID of the product.
Header Color	Set the color of the top part (header) of the Web Remote screen.

After setting each item, click "Apply" to complete the setting.

Audio-Technica LINK Mode

Set the operation mode under Audio-Technica LINK (P.60).

1. Select "Primary" or "Extension".
2. Click "Apply".
 - Setting is complete.

Front Panel Display

Set whether or not to display error messages on the display of this product.

1. Click the switch to turn on/off the setting.
 - The setting is turned ON (blue)/OFF (no color) each time the switch is clicked.
2. Click "Apply".
 - Setting is complete.

Setting the system details (Settings & Maintenance)

Network in System Settings

Network Configuration (ATDM-1012DAN only)

1. Set each item.

Mode	Set the network configuration mode to suit the environment.
Latency	Set the Dante port latency.

2. Click "Apply".
 - Setting is complete.

Dante & Audio Port Settings (ATDM-1012DAN only)

Set how to obtain IP addresses, and specify each value.

1. From "IP Config Mode", select "Auto" or "Static".

Auto	IP addresses are automatically assigned from the DHCP server, etc.
Static	Specify static IP addresses. Selecting "Static" enables the "IP Address", "Subnet Mask", and "Gateway Address" fields. Enter the addresses you want to specify.

2. Click "Apply".
 - Setting is complete.

IP Control & Web Remote Port Settings

Set how to obtain IP addresses, and specify each value.

1. From "IP Config Mode", select "Auto" or "Static".

Auto	IP addresses are automatically assigned from the DHCP server, etc.
Static	Specify static IP addresses. Selecting "Static" enables the "IP Address", "Subnet Mask", and "Gateway Address" fields. Enter the addresses you want to specify. The default value is "192.168.33.102".

2. Click "Apply".
 - Setting is complete.

Allow Discovery

Set the product to be discovered automatically by "Locate".

1. Click the switch.
 - The setting is turned ON (blue)/OFF (no color) each time the switch is clicked.
 - When the function is turned on, the product can be identified by "Locate".
2. Click "Apply".
 - Setting is complete.

IP Control Settings

Set the options relating to IP control.

1. Set each item.

Port Number	The port number of the IP control is displayed.
Notification	Receive notifications from IP-controlled devices.
Audio Level Notification*	Receive audio level notifications from IP-controlled devices.
Multicast Address*	Set the address for multicast.
Multicast Port Number*	Set the port number for multicast.

* This item can be set only when "Notification" is turned ON (blue).

2. Click "Apply".
 - Setting is complete.

NTP Settings

Set the NTP (Network Time Protocol).

1. Set each item.

Enabled	Set whether to enable or disable the NTP (Network Time Protocol).
Server Address	Set the NTP server address.
Port Number	Set the NTP port number.
Time Zone	Set the time difference from the UTC (Coordinated Universal Time).
Daylight Saving Time	Turn on/off the daylight saving time.
Start Date & Time	Set the starting date/time of daylight saving time.
End Date & Time	Set the ending date/time of daylight saving time.

2. Click "Apply".
 - Setting is complete.

User Access in System Settings

Default Front Panel Mode

Set the front panel mode when the power is on.

1. Select "Administrator" or "Operator".
2. Click "Apply".
 - Setting is complete.

Login Password

Set whether or not to require a password for Administrator login.

1. Click the switch to turn on/off the setting.
 - The setting is turned ON (blue)/OFF (no color) each time the switch is clicked.
2. Enter a desired password.
 - Create a password using 4 to 8 alphanumeric characters.
3. Click "Apply".
 - Setting is complete.

Operator Page Permissions

Set whether or not to limit the devices that can be accessed by the Operator.

1. Click the switch to turn on/off this function.
 - The setting is turned ON (blue)/OFF (no color) each time the switch is clicked.
2. Enter the IP addresses of the devices that can be accessed by the Operator.
 - Up to 5 devices can be registered.
3. Click "Apply".
 - Setting is complete.
 - No other device can be accessed by the Operator.

Setting the system details (Settings & Maintenance)

Audio in System Settings

Audio System

Check/change the audio-related system settings.

1. Set each item.

Gain Unit Type	Set the unit in which the gain is displayed for adjustment.
Delay Unit Type	Set the unit in which the delay time is displayed for setting.
Input EQ/DYN Display	Set the graph display for the Audio Input Settings screen.
Virtual Mic Mode	Select to include the virtual mic as an option in the input type pull-down menu.

2. Click "Apply".
 - Setting is complete.

Front Panel in System Settings

Levels

Set whether or not to enable input/output level adjustment for each channel on the front panel of the product.

1. Select/unselect the check box for each channel.
 - You can adjust the level of each selected channel.
2. Click "Apply".
 - Setting is complete.

Mute

Set whether or not to enable muting of each channel on the front panel of the product.

1. Select/unselect the check box for each channel.
 - Muting is possible for each selected channel.

LED Dimmer

Set whether or not to enable dimming of the LEDs (dimmed illumination) on the front panel of the product.

1. Click the switch to turn on/off the setting.
 - The setting is turned ON (blue)/OFF (no color) each time the switch is clicked.
2. Click "Apply".
 - Setting is complete.

Front Panel Restrictions

Set whether or not to enable preset recall on the front panel of the product.

1. Click the switch to turn on/off the setting.
 - The setting is turned ON (blue)/OFF (no color) each time the switch is clicked.
2. Click "Apply".
 - Setting is complete.

Utilities in System Settings

Firmware Update

Update the firmware of the product.

1. Check "Serial No.", "Device Name", and "Firmware Version" on the screen to see if this product is due for update.
2. Click "Browse".
 - The file selection screen appears.
3. Select and open the file of the latest version on the file selection screen.
4. Click "Update".
 - Update is started. When the update is complete, the completion screen appears.
5. Turn off the product, and then restart the product.
 - After the restart, reload the page in a web browser.

Language Pack Install

Install the language pack to allow Web Remote to be displayed in multiple languages.

1. Click "Browse".
 - The file selection screen appears.
2. Select and open the files of the desired languages on the file selection screen.
3. Click "Install".
 - Installation is started. When the installation is complete, the completion screen appears and you are automatically logged out.

Reset All Settings to Default

Reset the product to the factory defaults. (The firmware will remain the current version.)

1. Click "Reset".
 - The confirmation screen appears.
2. Check the information on the confirmation screen, and click "YES".
 - When the initialization is complete, the completion screen appears. Turn off the product.

Setting the system details (Settings & Maintenance)

Operator Page in Operator Access

Multi Operator Page

Set whether or not to use multiple operator pages.

- Click the switch to turn on/off the setting.
 - The setting is turned ON (blue)/OFF (no color) each time the switch is clicked.
- Click "Apply".
 - Setting is complete.

Array Mic Switch LINK

Set whether or not to share muting by the Mic Array switch between Audio-Technica LINK devices.

- Click the switch to turn on/off the setting.
 - The setting is turned ON (blue)/OFF (no color) each time the switch is clicked.
- Click "Apply".
 - Setting is complete.

How to view the Fader Settings screen

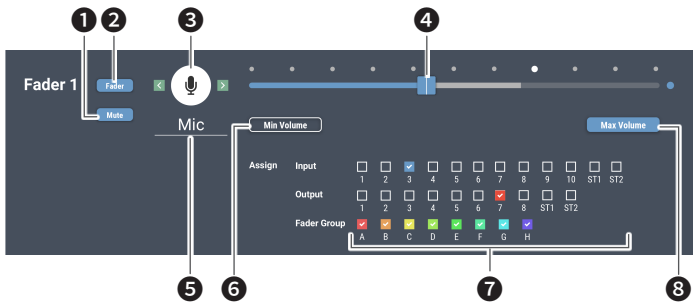

- Set whether or not to mute when the icon (3) is clicked on the Operator Page.
- Set whether or not to display the fader on the Operator Page.
- Select the icon to be displayed on the Operator Page.
- Adjust the volume.
- Set a desired name.
- Set the minimum fader level.
- Assign an input or output channel to the fader or set a fader group.
- Set the maximum fader level.

Fader Settings

Check/change the operations that can be performed on the Operator page.

- Enter the page name to be displayed in "Page Name".
- Set whether to select the check box in "Hide from List".
 - If the check box is selected, fader will be displayed only when accessing from an authorized IP address.
- Set each item.
 - Set each item by referring to "How to view the Fader Settings screen".
- Click "Apply".
 - Setting is complete.

Operator Page Restrictions

Set restrictions on the operations that can be performed on the Operator page.

- Set each item.

Preset Recall	Set whether or not to recall presets.
Num of Presets* ¹	Set the number of presets that can be recalled.
Resume Fader Position	Set whether or not to enable position resume for up to eight fader channels.
Logout Button	Set whether or not to display the Log Out button on the screen.
Array Mic Switch* ²	Set whether to place a button for turning the array mic on or off.
Tascam Button	Set whether or not to display the recording operation button.
Transport Layout	Change the location of the recording operation button.

*1 This item can be set when "Preset Recall" is turned on.

*2 This item can be set when Virtual Mic is selected in "Virtual Mic Mode".

- Click "Apply".
 - Setting is complete.

Presets in Presets

Presets

Check/change the preset settings currently registered in the product, and import/export preset files.

How to view the Presets screen

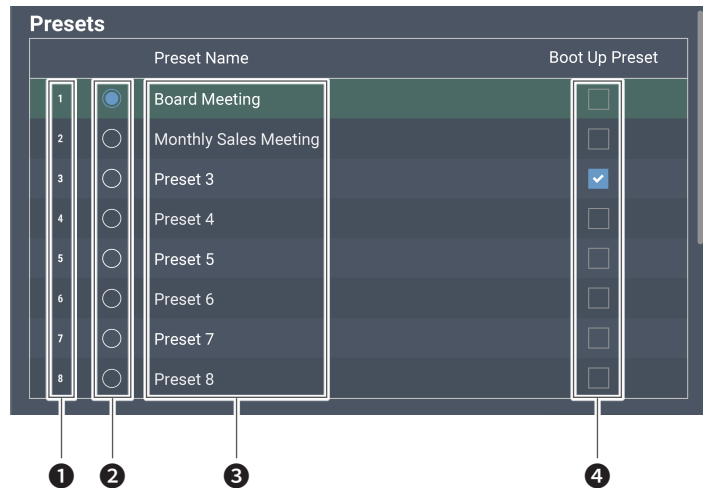

- Preset number
- Radio button
Select a preset.
- Preset name
Set a desired name.
- Boot up preset
Each time this product is started, the selected preset is recalled.

Setting the system details (Settings & Maintenance)

Exporting a preset

1. Click the radio button corresponding to the preset number from which you want to export.
 - Clicking the button selects the preset (the color turns to blue).
2. Click "Export".
3. Set the save location/file name, and export the file.

Importing a preset

A preset created elsewhere can be imported.

1. Click the radio button corresponding to the preset number to which you want to import.
 - Clicking the button selects the preset (the color turns to blue).
2. Click "Browse", and select the external file.
3. Click "Import".
 - The preset is imported.

Preset Recall LINK

1. Click the switch to turn on/off the setting.
 - The setting is turned ON (blue)/OFF (no color) each time the switch is clicked.

Preset Recall LINK	Set whether or not to link Preset Recall between Audio-Technica LINK devices.
Tascam Preset LINK	Set whether or not to recall by linking presets on the Tascam SS-R250N solid-state recorder when presets 1 to 3 are recalled.

2. Click "Apply".
 - Setting is complete.

Partial Preset in Presets

Unlike presets used to save settings for an entire device, these presets only save parameters selected by choice. Settings can be recalled without affecting parameters other than the saved parameters.

Changing a partial preset name

1. Click the partial preset name you want to change.
2. Enter the new partial preset name.

Setting partial preset parameters

1. Click the radio button corresponding to the partial preset number you want to set.
 - Clicking the button selects the preset (the color turns to blue).
2. Set parameters from "Partial Preset Parameters".
3. Click "Save".
 - The partial preset is saved.

Recalling a partial preset

1. Click the radio button corresponding to the partial preset number you want to recall.
 - Clicking the button selects the preset (the color turns to blue).
2. Click "Recall".

Exporting a partial preset

1. Click the radio button corresponding to the partial preset number you want to change.
 - Clicking the button selects the preset (the color turns to blue).
2. Click "Export".

Importing a partial preset

1. Click the radio button corresponding to the partial preset number to which you want to import.
 - Clicking the button selects the preset (the color turns to blue).
2. Click "Browse", and select the external file.
3. Click "Import".
 - The partial preset is imported.

Setting the system details (Settings & Maintenance)

4 Band EQ Library in Presets

4 Band EQ Library

You can import/export 4-band EQ patterns to be applied to audio inputs as a preset.

EQ Preset	A setting in which the EQ patterns for all bands are saved.
Library	A group that includes all presets.

Changing a preset name

1. Click the preset name you want to change.
2. Enter the preset name.

Exporting a preset/library

1. Click the radio button corresponding to the preset number from which you want to export.
 - Clicking the button selects the preset (the color turns to blue).
 - When exporting a library, you need not select all applicable presets.
2. Click "Export" from "EQ Preset"/"Library".

Importing a preset/library

1. Click the radio button corresponding to the preset number to which you want to import.
 - Clicking the button selects the preset (the color turns to blue).
 - When importing a library, you need not select all applicable presets.
2. Click "Browse" from "EQ Preset"/"Library" and select the external file.
3. Click "Import" from "EQ Preset"/"Library".
 - The preset/library is imported.

12 Band EQ Library in Presets

12 Band EQ Library

You can import/export 12-band EQ patterns to be applied to audio outputs as a preset.

EQ Preset	A setting in which the EQ patterns for all bands are saved.
Library	A group that includes all presets.

Changing a preset name

1. Click the preset name you want to change.
2. Enter the new preset name.

Exporting a preset/library

1. Click the radio button corresponding to the preset number from which you want to export.
 - Clicking the button selects the preset (the color turns to blue).
 - When exporting a library, you need not select all applicable presets.
2. Click "Export" from "EQ Preset"/"Library".

Importing a preset/library

1. Click the radio button corresponding to the preset number to which you want to import.
 - Clicking the button selects the preset (the color turns to blue).
 - When importing a library, you need not select all applicable presets.
2. Click "Browse" from "EQ Preset"/"Library" and select the external file.
3. Click "Import" from "EQ Preset"/"Library".
 - The preset/library is imported.

Logging in Logging

Logging

Set the options relating to log messages, and download log files.

Enabled	Set whether or not to save log messages.
Destination	Set whether to write log messages to the internal memory or transfer them to the Syslog server.
Log File	You can download the log file recorded to the internal memory by clicking "Download".

After setting each item, click "Apply" to complete the setting.

- Syslog is a standard for transferring log messages across IP networks. It is used for administration of computer systems and security monitoring.

Setting the system details (Settings & Maintenance)

System Info in System Info

System Info

System information, such as the various network settings and the product's serial number and firmware version, is displayed. Clicking "Export" will export system information to a text file.

Key functions

AEC (Acoustic Echo Canceler)

In meetings held between remote locations, such as teleconferencing, acoustic echoes can occur when the audio output from the speaker is picked up by a microphone. The audio from the other party is amplified by the speaker and can bounce off of the ceiling, walls or floors of the room, and, upon being picked up by the microphone, is returned to the other party along with your party's audio. The other party hears the delayed own audio, making it difficult to speak back.

Using the other party's signals as reference signals, the acoustic echo canceler removes only the echoes in the other party's audio from the audio signals sent from your party. This makes it possible to deliver clear audio, with no echoes, to the other party.

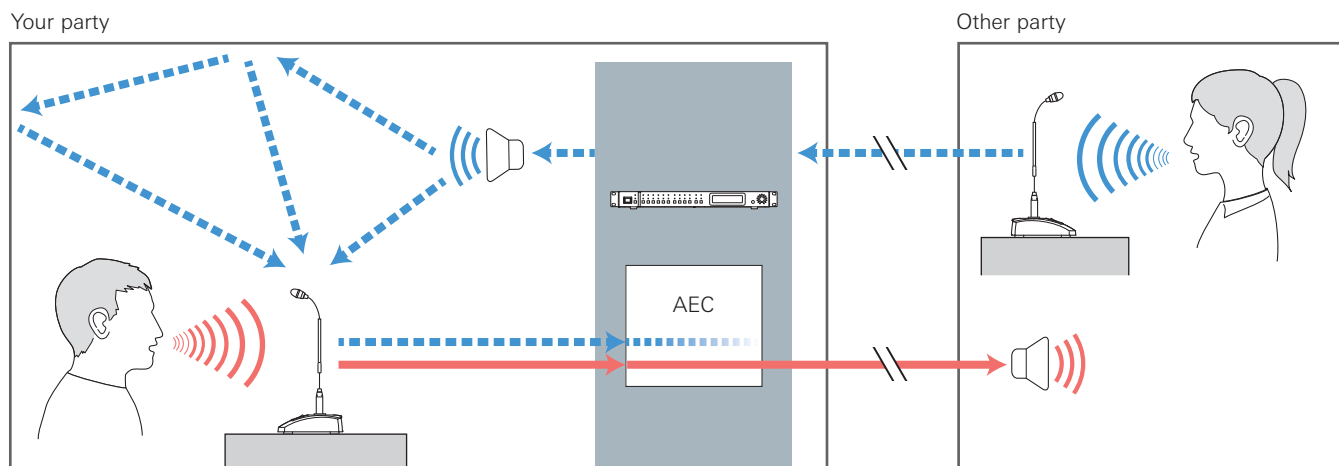

Key functions

Setting AEC

1. Click "AEC".



2. From "Mode", select "AEC".



3. From "AEC Reference", select the reference signal (the signal for removing echoes).

- In general, a signal from the other party is set as the reference signal.



4. Turn AEC ON for the microphone to be used (for each channel).



5. From the Matrix Assign screen "NC Bus Select", select the signal (output bus) to be returned to the other party.

- Perform this setting to use the noise canceling function. The noise canceling function is set for each bus. Access the Matrix Assign screen and set for each bus. When setting AEC, we recommend setting the noise canceling function on the Matrix Assign screen.



Key functions

- 6. Confirm that the ERL meter fluctuates.
 - Perform the following procedures as necessary.



- 7. Until the ERL meter is at 0 or less, adjust the distance between microphones, speaker positions, input level, etc.
- 8. If necessary, turn ON "NLP".
 - These features may increase the echo canceling effect.



Key functions

SmartMixer

The SmartMixer function is designed to automatically adjust the audio input and output of the microphone channel without picking up any unnecessary noise or allowing howling to occur in meetings where an unspecified large number of participants speak at the same time. It is particularly effective in meetings, such as a panel discussion, where the participants can speak at any given time. The automation of the otherwise cumbersome fader operation by an operator makes it possible to have stable and efficient operation. SmartMixer can be either “gate mode” or “gain sharing mode”.

Gate mode SmartMixer

When there is an audio input to a microphone, the corresponding channel automatically opens. If more than one microphone receives audio input, the audio inputs to all open channels are added. Simply adding the audio inputs tends to lower the howling margin, thereby reducing the audio quality. To address this issue, the gate mode SmartMixer attenuates the added audio inputs based on the number of open mic channels.

Gain sharing mode SmartMixer

This type of SmartMixer compares the audio input level of each mic channel against the total sum of the audio input levels from all open mic channels, and, based on the ratio, divides the gain among all the channels. With this, the total gain is always equal to one microphone (remains constant), whether the audio input is from one microphone or multiple microphones.

Setting Gate mode SmartMixer

Configure all settings using Web Remote.

1. Click “Smart Mix”.



2. Select the group to be set and select “Gate” from “Mode”.



3. Click the channel groups to be operated with the SmartMixer function and click “Enable”.



Key functions

- Set "Priority", "Can Cut", "Off Attenuation" and "Threshold" for each channel, as necessary.

Priority	When this is set to ON, the gate of this microphone input channel opens first over the other channels whose "Priority" is OFF. <ul style="list-style-type: none"> Depending on the setting of the priority mode, the gate may not open.
Can Cut	When this is set to ON for a channel whose "Priority" is ON, the gates of the other channels whose "Priority" is OFF close upon opening of the gate of this microphone input channel.
Off Attenuation	Set the attenuation level when the gate of the microphone input channel is closed.
Threshold	Set the threshold when the gate of the microphone input channel is closed.



- Set "Last Mic On", "Gate Hold Time", "NOMA", "Num of Open Mics", "Fixed Threshold", and "Threshold Level".

Last Mic On	When this is set to ON, the last opened microphone input channel gate remains open.
Hold Time	Set the time after the audio input is ceased until the microphone input channel gate is closed.
NOMA	This function is used to attenuate the output according to the number of open microphone input channel gates. It is recommended that "NOMA" be set to ON to prevent howling.
Num of Open Mics	Limit the number of microphone input channel gates that open simultaneously. Change this value according to the operating method.
Priority Mode	Either mode of the following applies when the number of microphone input channel gates that currently open reaches the "Num of Open Mics". Mode 1: Channels cannot be opened even if their "Priority" is ON. Mode 2: Channels can be opened if their "Priority" is ON.
Fixed Threshold	This function locks the level at which the microphone input channel gate opens.
Threshold Level	Set the level at which the microphone input channel gate opens.

Setting gain sharing mode SmartMixer

Configure all settings using Web Remote.

- Click "Smart Mix".



- Select the group to be set and select "Gain Share" from "Mode".



Key functions

- Click the channel groups to be operated with the SmartMixer function and click “Enable”.
 - It turns ON (purple) when clicked.



- Set “Weight” for each channel, as necessary.
 - The gain to be distributed can be adjusted. This can be used also to balance the background noise for each channel.
- Monitor the gain meter of each channel to confirm that the total gain is distributed based on the input signals.

Key functions

Audio-Technica LINK

Up to eight ATDM-1012 model mixers can be daisy-chained so that, as a whole system, it can handle audio inputs from 80 Mic/Line channels and 16 unbalanced stereo channels. The proprietary Audio-Technica LINK functionality enables the transmission of low-latency, high-speed audio bus signals between devices, making it possible to steadily control and transmit uncompressed audio signals. Furthermore, the model offers excellent workability as it conforms to the Ethernet standards and can be connected to generic LAN cables (shielded cables of Cat5e or above with the conductor diameter size of 24 AWG or larger).

Connection and setting procedures

1. Daisy-chain the ATDM-1012 devices (up to eight).
 - Do not connect units in a ring pattern. Make sure to leave one of the two LINK terminals at both ends of the connected ATDM-1012 devices open.
 - For connections, use a shielded LAN cable of Cat5e or above with a conductor diameter size of 24 AWG or larger.

Connection example

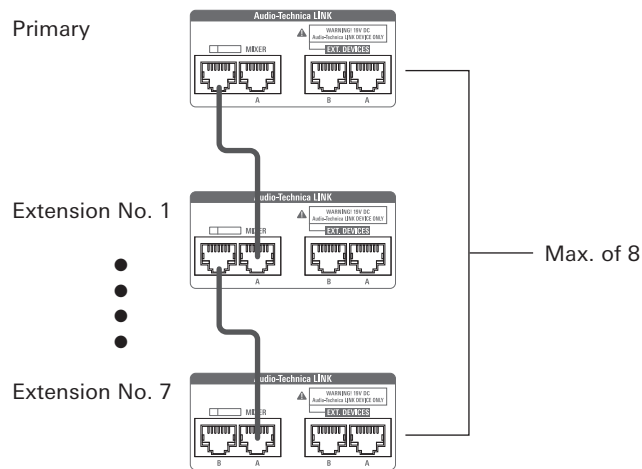

2. Launch Web Remote, and configure the settings related to the Audio-Technica LINK for each ATDM-1012.
3. In "Audio-Technica LINK Mode", set the ATDM-1012 connected to one of the two ends as "Primary".
 - Do not set any of ATDM-1012 devices connected in the middle as "Primary". The connection will not be recognized properly.

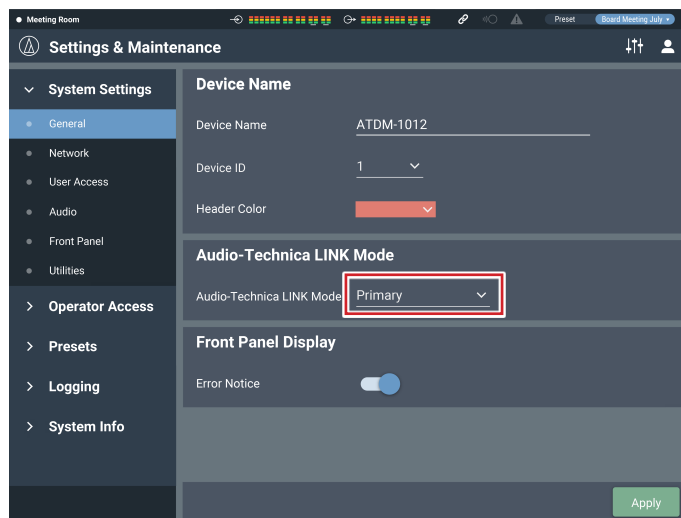

4. Set all other ATDM-1012 devices as "Extension".
 - Do not set more than one ATDM-1012 as "Primary".

• Settings for Primary/Extensions are also possible on the front panel. Turn the dial button on the Home screen to select "Set" and then press the dial button. Turn the dial button to go from "[1] System Settings" to "LINK Mode" and select between "Primary" and "Extension".

Key functions

Sharing audio buses

When using Audio-Technica LINK, audio buses 1 to 12, the AEC reference signal bus, and ducking trigger signal buses 1 to 4 are shared between devices.

Audio buses 1 to 12:

Signals assigned to each bus can be shared between the primary and all extensions. Audio channels can be created freely by setting the desired audio bus for each mixer.

AEC reference signal bus:

By sharing the AEC reference signal, echo canceling of audio shared between the linked primary and extensions is possible.

Ducking trigger signal bus:

By sharing the ducking trigger signal, ducking can be applied to the stereo input audio of each input audio shared between the linked primary and extensions.

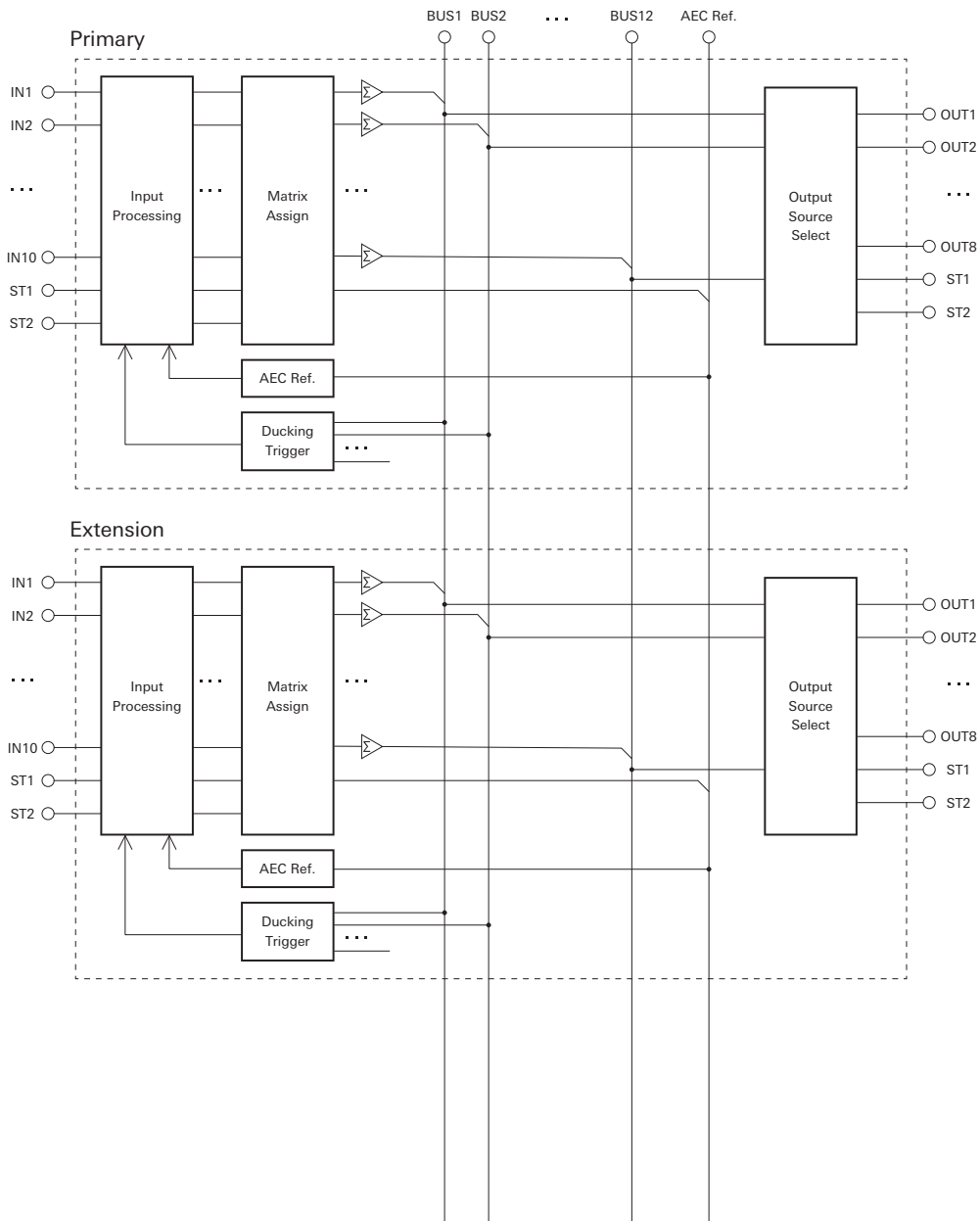

Key functions

Regarding the SmartMixer function and ducking function when using Audio-Technica LINK

SmartMixer function

- When connecting Audio-Technica LINK, extension settings will be overwritten with primary settings.
- Input channels set to the same group for the primary and extensions will operate as part of that group.
- All settings that can be set when "Mode" is set to "Gate" will change to the settings of the primary. Settings for channels on the input screen will operate using the settings of the extensions.

Ducking function

When using Audio-Technica LINK, the audio signals of buses 1 to 4 shared by each mixer can be individually set as triggers by each mixer.

Preset function

When using Audio-Technica LINK, turning on the "Preset Recall LINK" for the extension enables the preset of the same number as that of the primary to be applied automatically.

Operator screen

When using Audio-Technica LINK, the audio levels of each group assigned to each input channel of the primary and extensions will change in conjunction with group fader (A to H) operations that have been set on and used via a specific operator screen. Also, Signal/Peak signals on that group fader will be the maximum value for the input signal assigned to each group of the linked primary and extensions.

Key functions

Front panel operation restriction

The following two modes are available when operating the product with the buttons and the dial on the front panel.

Operator mode:

In this mode, daily operations are performed, such as loading the preset settings and adjusting the audio level.

Administrator mode:

In this mode, advanced settings can be configured by installing and implementing the product on-site.

When the power is turned on, the product usually starts in operator mode. This prevents accidental device setting changes or other troubles, and ensures a safe operation of the system.

This section explains how to restrict the front panel operation using Web Remote.

- The restriction cannot be activated in Advanced mode.

1. Select "Administrator", and click "Login".

- If a password has been set, log in by entering that password.
- If you are logged in as an operator, log out, and then log back in.

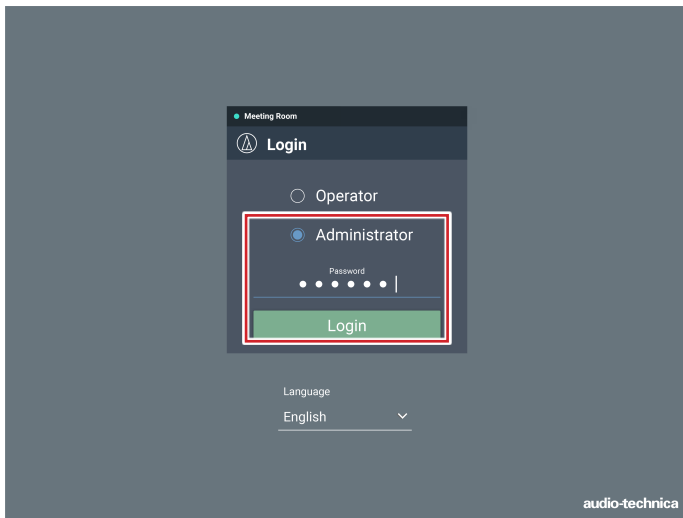

2. Click the icon (⚙️) on the top right of the screen.



3. Click "Front Panel".
4. In the "Levels" setting, set the operation restriction for the audio level adjustment.
 - If INPUT and OUTPUT for each channel are selected, the audio level for that channel can be adjusted.
 - Clear the check boxes not to allow these controls.
5. Set operation restrictions using "Mute" settings.
 - If INPUT and OUTPUT for each channel are selected, muting is possible.
 - Clear the check boxes not to allow these controls.
6. Using "Front Panel Restrictions", set whether or not to enable preset recall on the front panel of the product.
 - The setting is turned ON (blue)/OFF (no color) each time the switch is clicked.
7. Click "Apply".
 - Setting is complete.

Key functions

Recalling Preset

Operator screen

1. Click the green area at the top of the screen.

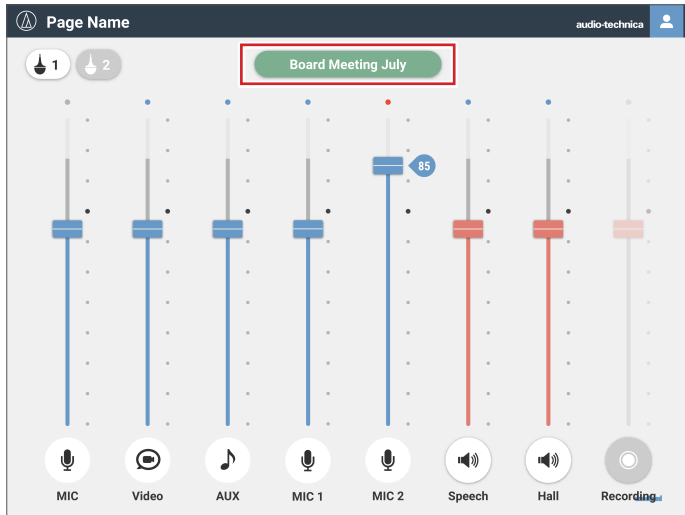

2. Select the preset of your choice from the pull-down menu.
 - The preset name appears, and the settings change based on the selected preset.

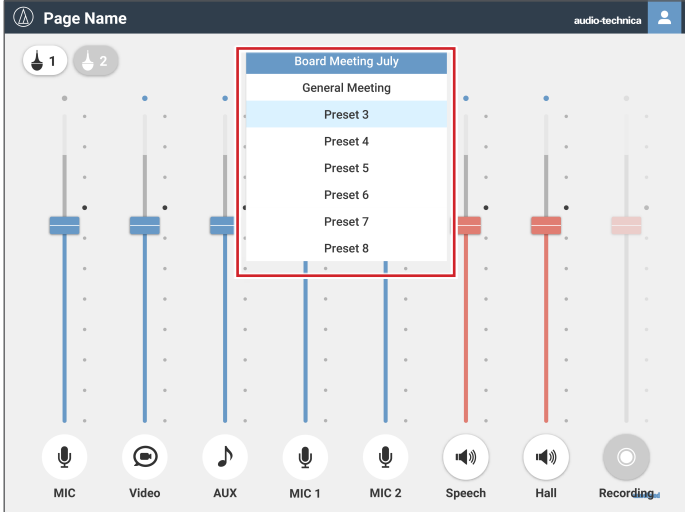

Administrator screen

1. Click "Preset" at the top right of the screen.



2. Select "Recall Preset" from the pull-down menu.



3. Select the preset of your choice.
 - The preset name appears, and the settings change based on the selected preset.

Key functions

Copying settings

The settings for a channel can be copied to another channel.

1. Click the icon (⚙️) of the source channel.



2. Click “Copy”.



3. Select the source channel.
 - To select another channel, click the currently selected channel to deselect it. The selection of the channel is canceled. Reselect the channel to copy.
4. Select the target channel.
 - To select another channel, click the currently selected channel to deselect it. The selection of the channel is canceled. Reselect the target channel.
5. Click “Paste”.
 - To cancel the copying, click “Cancel”. The screen returns to the previous screen.

Key functions

Resetting settings

The settings for a channel can be reset to the default settings.

1. Click the icon (⚙️) of the channel to reset.



2. Click "Reset".



Linking channels

Link channels to share the settings. Only the following channels can be linked.

Input channels	788, 9810
Sub channels	182, 384, 586, 788
Output channels	182, 384, 586, 788

1. Click the icon (⚙️) of the channels to be linked.



2. Click "Link 788".



3. Confirm that the channels have been linked.

- The settings of channel 8 are same as the settings of channel 7.
- The linked channel 8 is grayed out and cannot be used.

Key functions

Using the ES954 (Hanging Microphone Array)

Connecting and setting the ES954

1. Connect the ES954 to ATDM-1012.
 - Connect MIC1 to MIC4 of the ES954 to input channels 1 to 4 or 6 to 9 of the ATDM-1012.

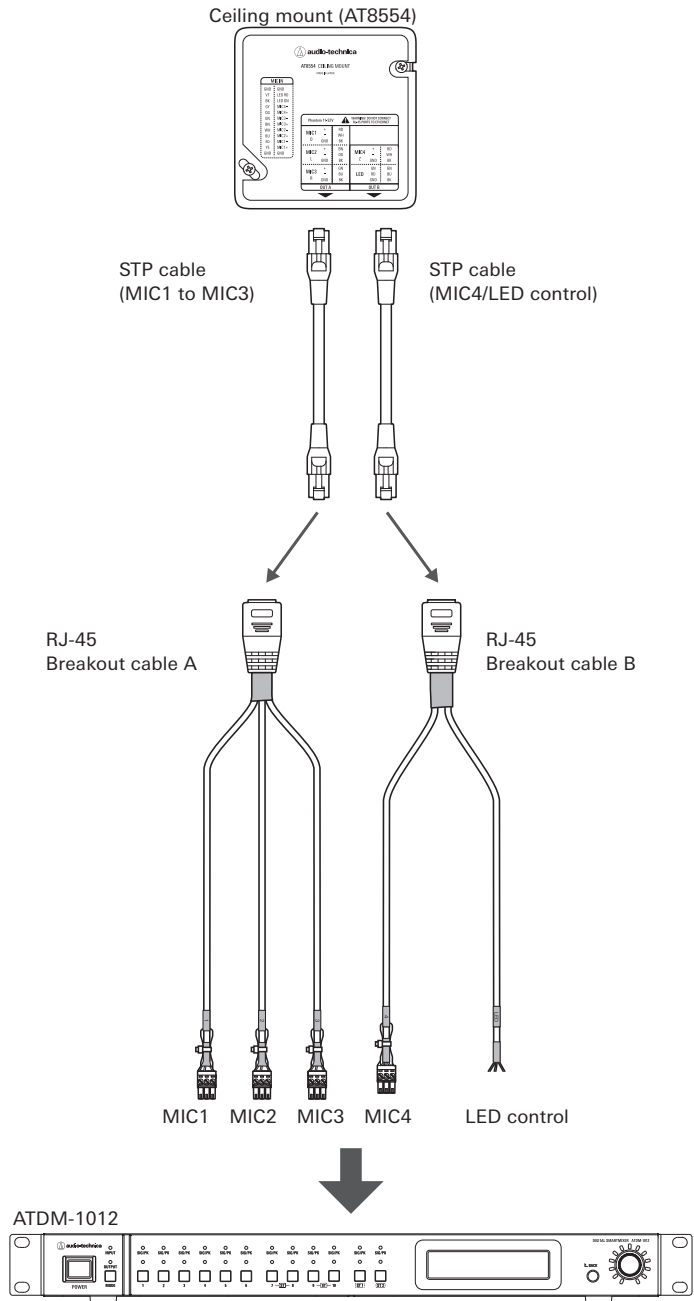

Setting the Administrator Page

1. Start Web Remote and log in as “Administrator”.

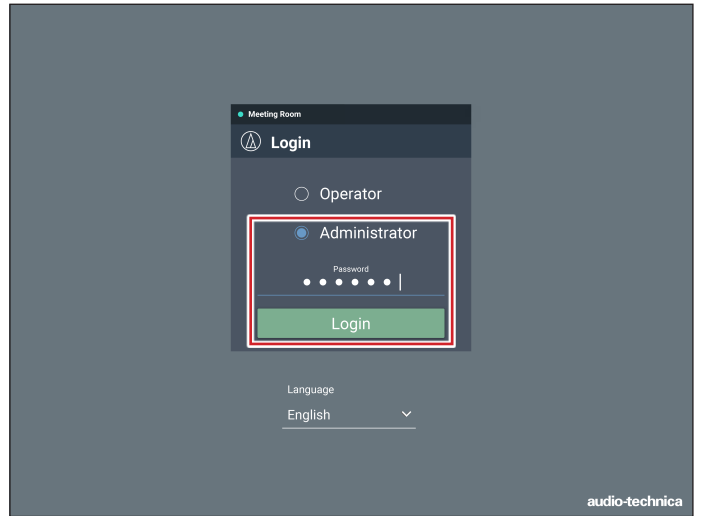

2. Click the icon (⚙️) at the upper right of the screen.



3. Click “Audio”.

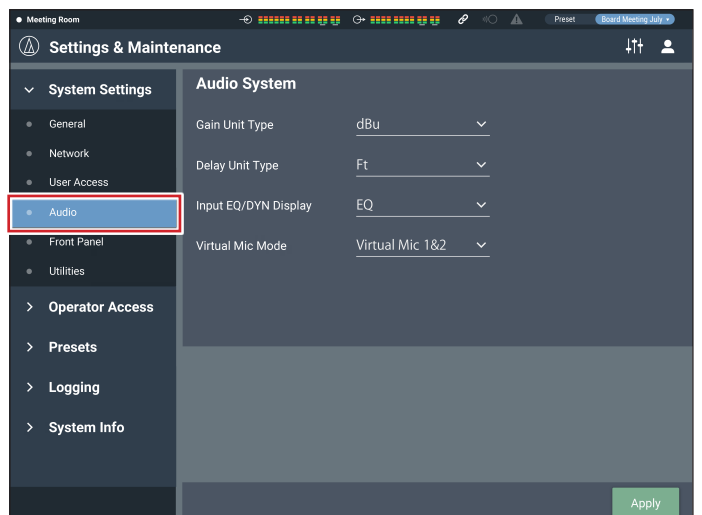

Key functions

4. Set the "Virtual Mic Mode".

Virtual Mic 1	The input type for input channels 1 to 4 is automatically set as "Virtual Mic 1". "Virtual Mic 1" can then be selected for the channels. The phantom power for input channels 1 to 4 turns "ON" automatically.
Virtual Mic 2	The input type for input channels 6 to 9 is automatically set as "Virtual Mic 2". "Virtual Mic 2" can then be selected for the channels. The phantom power for input channels 6 to 9 turns "ON" automatically.
Virtual Mic 1&2	The input type for input channels 1 to 4 is automatically set as "Virtual Mic 1", while the input type for input channels 6 to 9 is automatically set as "Virtual Mic 2". "Virtual Mic 1" or "Virtual Mic 2" can then be selected for the channels. The phantom power for input channels 1 to 4 and 6 to 9 turns "ON" automatically.

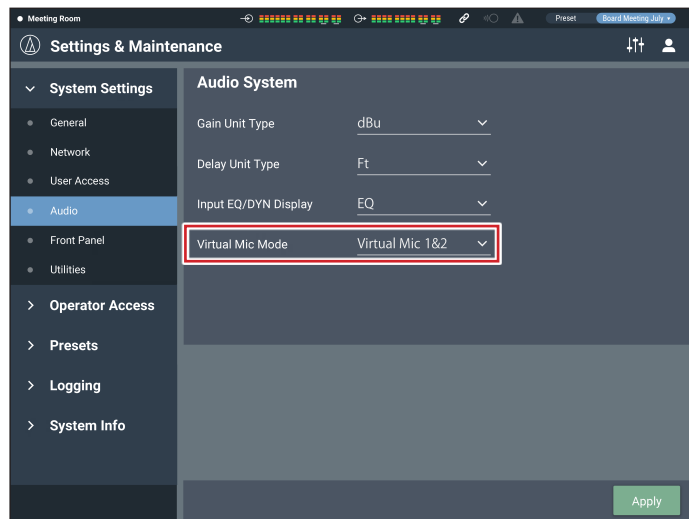

5. Click "Apply".

6. Click the screen switch icon .

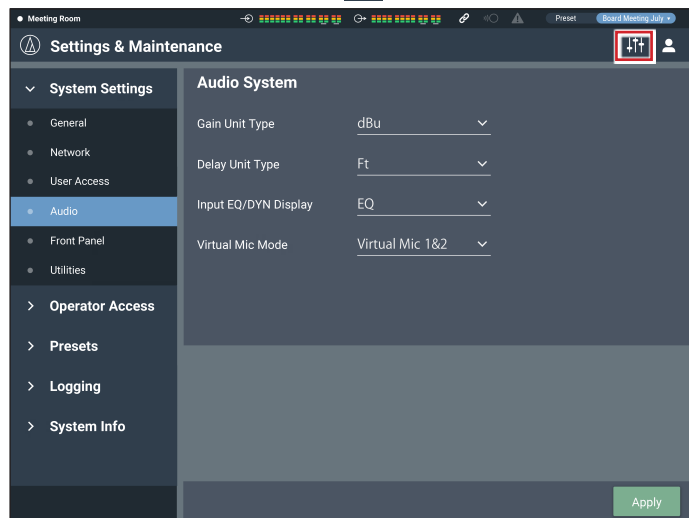

7. Set "Input gain", "Low-cut", "EQ", "Smart Mix", "Assign", and "Volume" as necessary.

- Input gain values on channels set as "Virtual Mic" are linked.
- "Low-cut", "EQ", "Smart Mix", "Bus Assignment", and "Volume" can be set for each channel.



8. Click the right side of the virtual mic box for additional settings.



Key functions

- Set the "Orientation", "Pattern", and "Tilt" of the virtual mic for each channel.

Orientation	Click the buttons around the virtual polar pattern to set the orientation of each virtual mic input channel. "Front" indicates the side that has the audio-technica logo on the ES954.
Pattern	Select "Wide", "Normal", or "OMNI" for the virtual mic polar pattern.
Tilt	Adjust the directivity of the vertical plane.

- Click "Apply".
 - Setting is complete.
- Log out and then log in again as an "Operator".
- You can turn the ES954 on or off by clicking the Array Mic icon.
 - The on or off status of the array mic is not saved. (After restarting the power, it is on.)
 - The "Array Mic Off" status cannot be configured as part of a preset.

Setting the Operator Page

- Start Web Remote and log in as "Administrator".

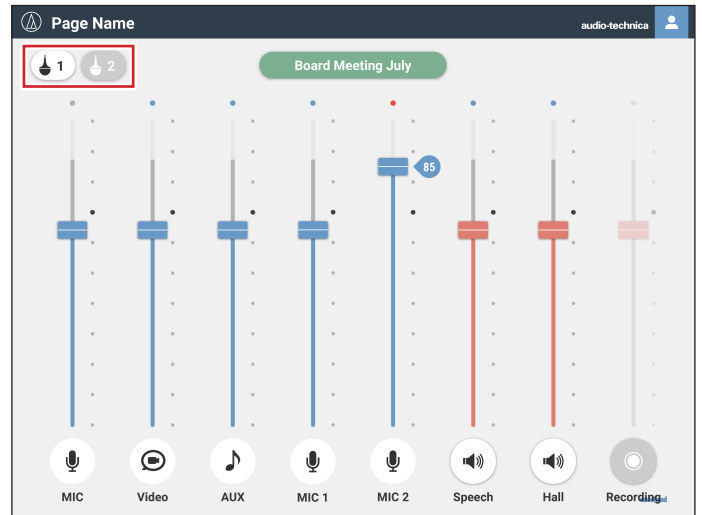
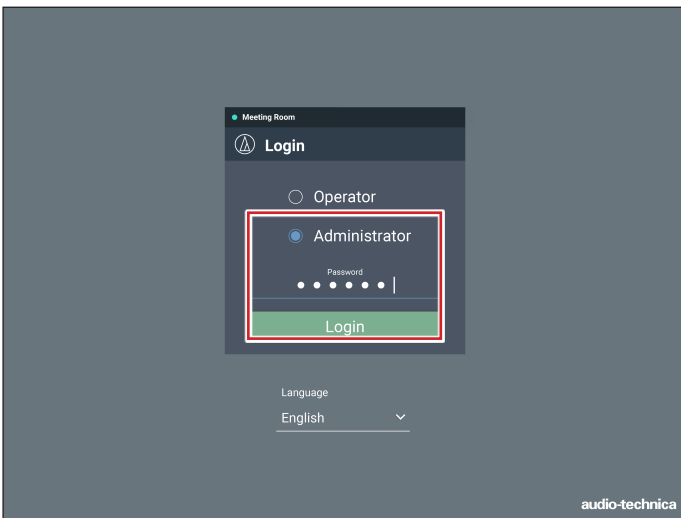

- Click the icon (⚙️) at the upper right of the screen.



- Click "Operator Page".
- Turn on "Array Mic Switch".

Key functions

Ducking function

The mixer has a ducking function on input channel ST. The function automatically reduces the background music volume or returns it to the original volume. It is useful for situations in which background music is playing and there are announcements to be made.

Enabling Ducking

1. Start Web Remote and log in as "Administrator".

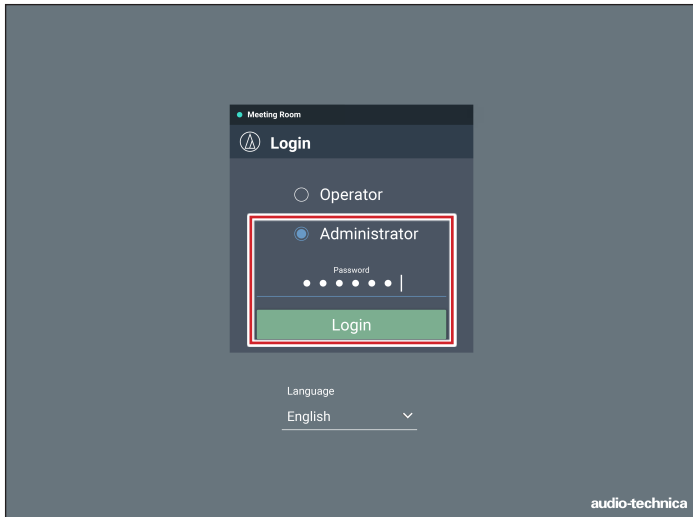

2. Click "Ducking".



3. Click "Enabled".

- The signal assigned to the selected bus becomes the trigger, and ducking is applied to each input channel.



4. Using the pull-down menu, select the trigger bus for the input channel to which ducking is to be applied.

- Ducking for the SUB input channel can only be set when 1/2 and 3/4 are paired.

Unit menu items

Administrator mode

Aud menu

Item name			Setting values	Default Setting	Presets Included	Resumed
Channel Setting	In 1 to 10	Source	Analog, Dante1 to 10*	Analog	✓	✓
		Unity	Mic, Line +4, Line 0, Line -10, Line -20	Mic	✓	✓
		Gain	+20dB to +60dB	+20dB	✓	✓
		Phantom	Off, On	Off	✓	✓
		Phase	Normal, Invert	Normal	✓	✓
		Low Cut	Off, On	Off	✓	✓
		FBS	Off, On	Off	✓	✓
		EQ	Off, On	Off	✓	✓
		Comp	Off, On	Off	✓	✓
		SM Group	Group 1 to 4	Group1	✓	✓
		SM Enable	Off, On	Off	✓	✓
		Priority	Off, On	Off	✓	✓
		AEC	Off, On	Off	✓	✓
		Level	-120.0dB to +10.0dB, -∞dB	-∞dB	✓	✓
	Mute	Off, On	Off	✓	✓	
	In S1	Source	Analog, USB	Analog	✓	✓
		Unity	Line 0, Line -10, Line -20	Line 0	✓	✓
		Gain	-20dB to +20dB	0dB	✓	✓
		EQ	Off, On	Off	✓	✓
		Level	-120.0dB to +10.0dB, -∞dB	-∞dB	✓	✓
		Mute	Off, On	Off	✓	✓
	In S2	Source	Analog, USB	Analog	✓	✓
		Unity	Line 0, Line -10, Line -20	Line 0	✓	✓
		Gain	-20dB to +20dB	0dB	✓	✓
		EQ	Off, On	Off	✓	✓
		Level	-120.0dB to +10.0dB, -∞dB	-∞dB	✓	✓
		Mute	Off, On	Off	✓	✓
	Sub 1 to 8	Source	Off, Input 1 to 10, Dante1 to 16*, Bus 1 to 8	Off	✓	✓
		Low Cut	Off, On	Off	✓	✓
		Level	-120.0dB to +10.0dB, -∞dB	-∞dB	✓	✓
		Mute	Off, On	Off	✓	✓
	Out 1 to 8	Source	Bus 1 to 12, DOUT 1 to 8	Bus 1 to 8	✓	✓
		Unity	+4dBu, 0dBV, -10dBV	+4dBu	✓	✓
		FBS	Off, On	Off	✓	✓
		EQ	Off, On	Off	✓	✓
		Complnsrt	PstFader, PreFader	PstFader	✓	✓
		Comp	Off, On	Off	✓	✓
		Level	-120.0dB to +10.0dB, -∞dB	-40.0dB	✓	✓
		Mute	Off, On	Off	✓	✓
	Out S1	Source	Bus 1/2, Bus 3/4, Bus 5/6, Bus 7/8, Bus 9/10, Bus 11/12, DOUT 9/10	Bus 9/10	✓	✓
		Unity	0dBV, -10dBV, -33dBV	0dBV	✓	✓
		FBS	Off, On	Off	✓	✓
		EQ	Off, On	Off	✓	✓
		Complnsrt	PstFader, PreFader	PstFader	✓	✓
		Comp	Off, On	Off	✓	✓
		Level	-120.0dB to +10.0dB, -∞dB	-40.0dB	✓	✓
		Mute	Off, On	Off	✓	✓
Out S2	Source	Bus 1/2, Bus 3/4, Bus 5/6, Bus 7/8, Bus 9/10, Bus 11/12	Bus 11/12	✓	✓	
	Unity	0dBV, -10dBV, -33dBV	0dBV	✓	✓	
	FBS	Off, On	Off	✓	✓	
	EQ	Off, On	Off	✓	✓	
	Complnsrt	PstFader, PreFader	PstFader	✓	✓	
	Comp	Off, On	Off	✓	✓	
	Level	-120.0dB to +10.0dB, -∞dB	-40.0dB	✓	✓	
	Mute	Off, On	Off	✓	✓	

* Displayed only for ATDM-1012DAN.

Unit menu items

Item name				Setting values	Default Setting	Presets Included	Resumed
Matrix Assign	01 Input -> Bus	In 1 to 10		Bus 1 to 12	Bus 1 to 10	✓	✓
		In S1		Bus 1 to 12	Bus 9/10	✓	✓
		In S2		Bus 1 to 12	Bus 11/12	✓	✓
		Sub 1 to 8		-	-	✓	✓
	02 Bus -> Input	Bus 1 to 8		Input 1 to 10, S1, S2	Input 1 to 8	✓	✓
		Bus 9L		Input 1 to 10, S1, S2	Input 9/S1	✓	✓
		Bus 10L		Input 1 to 10, S1, S2	Input 10/S1	✓	✓
Bus 11L			Input 1 to 10, S1, S2	Input S2	✓	✓	
USB OUT Setting	USB OUT	Out 1, 2		Off, Bus 1 to 12	Off	✓	✓
		Level		-120.0dB to 0.0dB, -∞dB	0.0dB	✓	✓
AEC Setting	AEC Setting	Mode		Off, AEC, NC	Off	✓	✓
Oscillator	Oscillator	Output		Off, On	Off	-	-
		Wave		Sin 100Hz, Sin 1kHz, Sin 10kHz, Pink	Sin 1kHz	-	-
		Level		-120dB to 0dB, -∞dB	-∞dB	-	-
	OSC	Out		-	-	-	-

Pst menu

Item name				Setting values	Default Setting	Presets Included	Resumed
Recall Presets	01 Preset 1 to 08 Preset 8	Recall Preset?	Completed!	-	-	-	-
Save Presets	01 Preset 1 to 08 Preset 8	Save Preset?	Completed!	-	-	-	-
BootUp Presets				Off, On	Off	-	✓

Unit menu items

Set menu

Item name			Setting values	Default Setting	Presets Included	Resumed	
System Setting	Device Name		(Maximum 30 characters (ASCII code only))	ATDM-1012	-	✓	
	Device ID		0 to 255	0	-	✓	
	LINK Mode		Extension, Primary	Primary	-	✓	
	Panel Err Notice		Off, On	On	-	✓	
	Panel Mode	Panel Mode		Operator, Administrator	Administrator	-	✓
		Admin.Pwd. Login		Off, On	Off	-	✓
		Admin. Password		(empty), (Minimum 4, Maximum 8 characters (alphabet and number only))	(empty)	-	✓
	Network Config*	Config Mode		Switched, Redundant Audio, Split	Switched	-	✓
		Latency		250usec, 500usec, 1msec, 2msec, 5msec	1msec	-	✓
	IP Setting	IP Port Set.	IP Config Mode	Auto, Static	Auto	-	✓
			IP Address	0.0.0.0 to 255.255.255.255	empty	-	✓
			Subnet Mask	0.0.0.0 to 255.255.255.255	empty	-	✓
			Gateway Address	0.0.0.0 to 255.255.255.255	empty	-	✓
		Dante Port Set.*	IP Config Mode	Auto, Static	Auto	-	✓
			IP Address	0.0.0.0 to 255.255.255.255	XXX.XXX.XXX.XXX	-	✓
			Subnet Mask	0.0.0.0 to 255.255.255.255	XXX.XXX.XXX.XXX	-	✓
	Gateway Address	0.0.0.0 to 255.255.255.255	XXX.XXX.XXX.XXX	-	✓		
	Allow Discovery		Off, On	On	-	✓	
	IP Ctrl Setting	IP Ctrl Port No		00001 to 65535	17300	-	✓
		IP Ctrl Ntfy		Off, On	Off	-	✓
		Audio Level Ntfy		Off, On	Off	-	✓
		M-cast Adrs		000.000.000.000 to 255.255.255.255	225.000.000.100	-	✓
		M-cast Port No		00001 to 65535	17000	-	✓
NTP Setting	NTP		Off, On	Off	-	✓	
Reset All Dflt.	Reset All to Dflt? OK, Cancel	Need Reboot. OK? OK, Cancel	-	-	-	-	

* Displayed only for ATDM-1012DAN.

Unit menu items

Item name				Setting values	Default Setting	Presets Included	Resumed	
System Info	Device Name			-	ATDM-1012	-	-	
	Device ID			-	0	-	-	
	Serial Number			-	XXXXXXXX	-	-	
	FW Version			-	XX.XX.XX	-	-	
	IP Config Mode			-	Auto	-	-	
	IP Address			-	XXX.XXX.XXX. XXX	-	-	
	Subnet Mask			-	XXX.XXX.XXX. XXX	-	-	
	Gateway Address			-	XXX.XXX.XXX. XXX	-	-	
	Mac Address			-	XX-XX-XX-XX- XX-XX	-	-	
	Dante*	Device Name			-	ATDM1012- XXXXXX	-	-
		Firmware Ver.			-	XX.XX.XX.XX	-	-
		Config Mode			-	Switched	-	-
		Connect Status-P			-	N/C	-	-
		IP Mode-P			-	Auto	-	-
		IP Address-P			-	XXX.XXX.XXX. XXX	-	-
		Subnet Mask-P			-	XXX.XXX.XXX. XXX	-	-
		Gateway Adrs-P			-	XXX.XXX.XXX. XXX	-	-
		Mac Address-P			-	XX-XX-XX- XXXX-XX	-	-
		Connect Status-S			-	N/C	-	-
		IP Mode-S			-	Auto	-	-
		IP Address-S			-	XXX.XXX.XXX. XXX	-	-
		Subnet Mask-S			-	XXX.XXX.XXX. XXX	-	-
		Gateway Adrs-S			-	XXX.XXX.XXX. XXX	-	-
		Mac Address-S			-	XX-XX-XX- XXXX-XX	-	-
		Latency			-	1msec	-	-
		Clock Status			-	N/A	-	-
	Allow Discovery			-	On	-	-	
	IP Ctrl Port No			-	17300	-	-	
	IP Ctrl Ntfy			-	Off	-	-	
	Audio Level Ntfy			-	Off	-	-	
	M-cast Adrs			-	225.000.000.100	-	-	
	M-cast Port No			-	17000	-	-	
	NTP			-	Off	-	-	
NTP Adrs			-	(empty)	-	-		
NTP Port			-	00123	-	-		
Time Zone			-	00:00	-	-		
LINK Status			-	Off	-	-		
LINK Mode			-	Primary	-	-		
No.ofExtension A			-	-	-	-		
No.ofExtension B			-	-	-	-		
No.ofExtension C			-	-	-	-		
No.ofExtension D			-	-	-	-		
Logging	Logging			Off, On	On	-	✓	
	Destination			Internal, Syslog	Internal	-	✓	
Presets	Recall Presets	Preset 1 to 8	Recall Preset?	Completed!	-	-	-	
	Save Presets	Preset 1 to 8	Save Preset?	Completed!	-	-	-	
	BootUp Presets			Off, On	Off	-	✓	

* Displayed only for ATDM-1012DAN.

Unit menu items

Operator mode

Lvl menu

Item name				Setting values	Default Setting	Presets Included	Resumed
In 1 to 10	Level			-120.0dB to +10.0dB, -∞dB	-∞dB	✓	✓
	Mute			Off, On	Off	✓	✓
In S1, S2	Level			-120.0dB to +10.0dB, -∞dB	-∞dB	✓	✓
	Mute			Off, On	Off	✓	✓
Sub 1 to 8	Level			-120.0dB to +10.0dB, -∞dB	-∞dB	✓	✓
	Mute			Off, On	Off	✓	✓
Out 1 to 8	Level			-120.0dB to +10.0dB, -∞dB	-40.0dB	✓	✓
	Mute			Off, On	Off	✓	✓
Out S1, S2	Level			-120.0dB to +10.0dB, -∞dB	-40.0dB	✓	✓
	Mute			Off, On	Off	✓	✓

Pst menu

Item name				Setting values	Default Setting	Presets Included	Resumed
Recall Presets	Preset 1 to 8	Recall Preset?	Completed!	-	-	-	-

Unit menu items

Set menu

Item name		Setting values	Default Setting	Presets Included	Resumed	
System Info	Device Name	-	ATDM-1012	-	-	
	Device ID	-	0	-	-	
	Serial Number	-	XXXXXXXX	-	-	
	FW Version	-	XX.XX.XX	-	-	
	IP Config Mode	-	Auto	-	-	
	IP Address	-	XXX.XXX.XXX. XXX	-	-	
	Subnet Mask	-	XXX.XXX.XXX. XXX	-	-	
	Gateway Address	-	XXX.XXX.XXX. XXX	-	-	
	Mac Address	-	XX-XX-XX-XX- XX-XX	-	-	
	Dante*	Device Name	-	ATDM1012- XXXXXX	-	-
		Firmware Ver.	-	XX.XX.XX.XX	-	-
		Config Mode	-	Switched	-	-
		Connect Status-P	-	N/C	-	-
		IP Mode-P	-	Auto	-	-
		IP Address-P	-	XXX.XXX.XXX. XXX	-	-
		Subnet Mask-P	-	XXX.XXX.XXX. XXX	-	-
		Gateway Adrs-P	-	XXX.XXX.XXX. XXX	-	-
		Mac Address-P	-	XX-XX-XX- XXXX-XX	-	-
		Connect Status-S	-	N/C	-	-
		IP Mode-S	-	Auto	-	-
		IP Address-S	-	XXX.XXX.XXX. XXX	-	-
		Subnet Mask-S	-	XXX.XXX.XXX. XXX	-	-
		Gateway Adrs-S	-	XXX.XXX.XXX. XXX	-	-
		Mac Address-S	-	XX-XX-XX- XXXX-XX	-	-
		Latency	-	1msec	-	-
	Clock Status	-	N/A	-	-	
	Allow Discovery	-	On	-	-	
	IP Ctrl Port No	-	17300	-	-	
	IP Ctrl Ntfy	-	Off	-	-	
	Audio Level Ntfy	-	Off	-	-	
	M-cast Adrs	-	225.000.000.100	-	-	
	M-cast Port No	-	17000	-	-	
NTP	-	Off	-	-		
NTP Adrs	-	(empty)	-	-		
NTP Port	-	00123	-	-		
Time Zone	-	00:00	-	-		
LINK Status	-	Off	-	-		
LINK Mode	-	Primary	-	-		
No.ofExtension A	-	-	-	-		
No.ofExtension B	-	-	-	-		
No.ofExtension C	-	-	-	-		
No.ofExtension D	-	-	-	-		

* Displayed only for ATDM-1012DAN.

Web Remote menu items

Audio Settings-Input

Input

Item name		Setting values	Default Setting	Presets Included	Resumed
Input channels 1 to 10	CH #	CH 1 to 10	-	-	-
	Mode Select	Analog: MIC, LINE +4dBu, LINE 0dBV, LINE -10dBV, LINE -20dBV, Dante*	MIC	✓	✓
	Input gain	+20dB to +60dB -20dBu to -60dBu	+20	✓	✓
	Phantom (+48V)	On, Off	Off	✓	✓
	Phase	On, Off	Off	✓	✓
	Lowcut	On, Off	Off	✓	✓
	4 Band EQ (EQ)	On, Off	Off	✓	✓
	CMP	On, Off	Off	✓	✓
	FBS	On, Off	Off	✓	✓
	CH Name	(Maximum 10 characters)	CH 1 to 10	✓	✓
	CH Color	Green, Yellow, Brown, Red, Pink, Blue, Gray, Dark Gray	Green	✓	✓
	CH mute (Mute)	On, Off	Off	✓	✓
	Levels	-∞, -120dB to +10dB	-∞	✓	✓
	Max Volume	On, Off	Off	✓	✓
	Min Volume	On, Off	Off	✓	✓
	Fader Group	A to H, OFF	OFF	✓	✓
	Copy	-	-	-	-
Reset	-	-	-	-	
Input channels ST1, ST2	CH #	ST1, ST2	-	-	-
	Mode Select	Analog: LINE 0dBV, LINE -10dBV, LINE -20dBV USB	LINE 0dBV	✓	✓
	Input gain	-20dB to +20dB	0	✓	✓
	4 Band EQ (EQ)	On, Off	Off	✓	✓
	CH Name	(Maximum 10 characters)	CH ST 1, CH ST 2	✓	✓
	CH Color	Green, Yellow, Brown, Red, Pink, Blue, Gray, Dark Gray	Green	✓	✓
	CH mute (Mute)	On, Off	Off	✓	✓
	Levels	-∞, -120dB to +10dB	-∞	✓	✓
	Max Volume	On, Off	Off	✓	✓
	Min Volume	On, Off	Off	✓	✓
	Fader Group	A to H, OFF	OFF	✓	✓
	Copy	-	-	-	-
Reset	-	-	-	-	
Input channels SUB 1 to 8	CH #	SUB 1 to 8	-	-	-
	Mode Select	OFF Analog: 1 to 10 Dante1 to 16* Bus 1	OFF	✓	✓
	Lowcut	On, Off	Off	✓	✓
	CH Name	(Maximum 10 characters)	SUB 1 to 8	✓	✓
	CH Color	Green, Yellow, Brown, Red, Pink, Blue, Gray, Dark Gray	Green	✓	✓
	CH mute (Mute)	On, Off	Off	✓	✓
	Levels	-∞, -120dB to +10dB	-∞	✓	✓
	Max Volume	On, Off	Off	✓	✓
	Min Volume	On, Off	Off	✓	✓
	Fader Group	A to H, OFF	OFF	✓	✓
	Copy	-	-	-	-
	Reset	-	-	-	-
	Link 1&2	Link 1&2, Unlink 1&2	Unlink 1&2	✓	✓
	Link 3&4	Link 3&4, Unlink 3&4	Unlink 3&4	✓	✓
Link 5&6	Link 5&6, Unlink 5&6	Unlink 5&6	✓	✓	
Link 7&8	Link 7&8, Unlink 7&8	Unlink 7&8	✓	✓	

* Displayed only for ATDM-1012DAN.

Web Remote menu items

Item name				Setting values	Default Setting	Presets Included	Resumed
Feedback Suppressor Setting	CH 1 to 10, ST 1, ST 2	Band #1 to 8	Frequency	-	-	-	-
			Band	On, Off	Off	✓	✓
		Detection		Low, Mid, High	High	✓	✓
		Response		Slow, Fast	Fast	✓	✓
		Reset		On, Off	Off	-	-
		All Static		On, Off	Off	-	-
4 Band EQ Settings	Mode change			Easy mode ↔ Expert mode	Expert mode	-	✓
	Easy mode	Type Select		High, Mid, Low	Mid	✓	✓
		Tone		Warm, Neutral, Bright	Neutral	✓	✓
	Expert mode	Band #1 Enable		On, Off	On	✓	✓
		Band #1 Gain		-18dB to +18dB	0	✓	✓
		Band #1 Frequency		20Hz to 20kHz	25	✓	✓
		Band #1 Q value		0.3 to 60	0.75	✓	✓
		Band #1 Filter type		HPF, LSH, PEQ	PEQ	✓	✓
		Band #2 Enable		On, Off	On	✓	✓
		Band #2 Gain		-18dB to +18dB	0	✓	✓
		Band #2 Frequency		20Hz to 20kHz	63	✓	✓
		Band #2 Q value		0.3 to 60	0.75	✓	✓
		Band #3 Enable		On, Off	On	✓	✓
		Band #3 Gain		-18dB to +18dB	0	✓	✓
		Band #3 Frequency		20Hz to 20kHz	6.3k	✓	✓
		Band #3 Q value		0.3 to 60	0.75	✓	✓
		Band #4 Enable		On, Off	On	✓	✓
		Band #4 Gain		-18dB to +18dB	0	✓	✓
		Band #4 Frequency		20Hz to 20kHz	16k	✓	✓
	Band #4 Q value		0.3 to 60	0.75	✓	✓	
	Band #4 Filter type		HPF, LSH, PEQ	PEQ	✓	✓	
	Flat			-	-	-	-
	Recall EQ Preset			-	-	✓	✓
Save EQ Preset			-	-	✓	✓	
Reset			-	-	-	-	
Dynamics Setting	Comp/DeEsser			Comp, DeEsser	Comp	✓	✓
	Compressor	Ratio		1:1.4, 1:2, 1:4, 1:6, 1:10, 1:∞	1:2	✓	✓
		Threshold		-60 to 0dB	-10	✓	✓
		Attack		0ms, 0.25ms, 0.5ms, 1ms, 2ms, 4ms, 8ms, 16ms, 32ms, 100ms	1	✓	✓
		Release		50ms, 100ms, 200ms, 400ms, 800ms, 1000ms, 2000ms	400	✓	✓
	Output	Gain		+10dB to -10dB	0	✓	✓
	DeEsser	Band #1 Frequency		20Hz to 20kHz	1.6k	✓	✓
		Band #1 Q value		0.3 to 60	0.75	✓	✓
		Band #1 Gain		0dB to +18dB	0	✓	✓
		Band #1 Filter type		HPF, LSH, PEQ	PEQ	✓	✓
		Band #2 Frequency		20Hz to 20kHz	1.6k	✓	✓
		Band #2 Q value		0.3 to 60	0.75	✓	✓
		Band #2 Gain		0dB to +18dB	0	✓	✓
		Band #2 Filter type		HPF, LSH, PEQ	PEQ	✓	✓
Lowcut		On, Off	On	✓	✓		
Listen		On, Off	On, Off	Off	-	-	

Web Remote menu items

Smart Mix

Item name			Setting values	Default Setting	Presets Included	Resumed
Smart Mix	Smart Mix Group		Group 1 to 4	Group 1	✓	✓
	Mode		Off, Gate, Gain Share	Gain Share	✓	✓
	Last Mic On		On, Off	Off	✓	✓
	Hold Time		0.1 to 10.0 seconds	2.5	✓	✓
	NOMA		On, Off	Off	✓	✓
	Num of Open Mics		1 to 10	6	✓	✓
	Priority Mode		Mode 1, Mode 2	Mode 1	✓	✓
	Fixed Threshold		On, Off	Off	✓	✓
	Threshold Level		-80 to 0	-50	✓	✓

AEC

Item name			Setting values	Default Setting	Presets Included	Resumed	
AEC/NC	Mode		Off, AEC, NC	Off	✓	✓	
	AEC Reference		IN6, IN10, IN ST1, IN ST2, OUT1 to 8, OUT ST1, OUT ST2, External	OUT1	✓	✓	
	Send Reference for External		On, Off	Off	✓	✓	
	NC Settings	NC Attenuation Level		0dB to 20dB	6	✓	✓
		NLP		On, Off	Off	✓	✓
	NLP Sensitivity		Low, Mid, High	Mid	✓	✓	

Ducking

Item name			Setting values	Default Setting	Presets Included	Resumed
Ducking	Target		ST1, ST2, SUB 1/2, SUB 3/4	-	-	-
	Enabled		On, Off	Off	✓	✓
	Triggered by		Bus 1 to 4	Bus 1	✓	✓

CMP/FBS

Item name			Setting values	Default Setting	Presets Included	Resumed
CMP/FBS	IN 1 to 10		Off, CMP, FBS	Off	✓	✓
	OUT 1 to 8		Off, CMP, FBS	Off	✓	✓
	ST1, ST2		Off, CMP, FBS	Off	✓	✓

Copy

Item name			Setting values	Default Setting	Presets Included	Resumed
Copy			-	-	-	-

Web Remote menu items

Matrix

Item name			Setting values	Default Setting	Presets Included	Resumed
Input channels 1 to 10	CH #		CH 1 to 10	-	-	-
	Bus Assign 1 to 12		Off, Post (SmartMix Bus), Pre	-	✓	✓
	Bus Assign Level		$-\infty$, -120dB to 0dB	0	✓	✓
	Smart Mix	SmartMix Group	G1 to G4	G1	✓	✓
		Smart Mix	Enable, Disable	Disable	✓	✓
	AEC		Enable, Disable	Disable	✓	✓
Input channels ST1, ST2	CH #		ST1, ST2	-	-	-
	Bus Assign 1 to 12		Off, Post (SmartMix Bus), Pre	-	✓	✓
	Bus Assign Level		$-\infty$, -120dB to 0dB	0	✓	✓
	Mono Button		On, Off	Off	✓	✓
Input channels SUB 1 to 8	CH #		SUB 1 to 8	-	-	-
	Bus Assign 1 to 12		Off, On (Pre)	Off	✓	✓
Bus 1 to 12	Bus Stereo LINK Bus 5-6, Bus 7-8, Bus 9-10, Bus 11-12		Off, On	Off: Bus 5-6, Bus 7-8 On: Bus 9-10, Bus 11-12	✓	✓
	NC Bus Select		Bus 1 to 12	Bus 1	✓	✓

Web Remote menu items

Audio Settings-Output

Output

Item name				Setting values	Default Setting	Presets Included	Resumed
Channel 1 to 8	CH #			OUT 1 to 8	-	-	-
	Source			Bus 1 to 12, Direct Out 1 to 8	Bus 1 to 8	✓	✓
	Unity			+4dBu, 0dBV, -10dBV	+4dBu	✓	✓
	FBS			On, Off	Off	✓	✓
	EQ			On, Off	Off	✓	✓
	CMP			On, Off	Off	✓	✓
	LMT			On, Off	Off	✓	✓
	Delay	Enabled		On, Off	Off	✓	✓
	CH Name			(Maximum 30 characters (ASCII code only))	OUT 1 to 8	✓	✓
	CH Color			Green, Yellow, Brown, Red, Pink, Blue, Gray, Dark Gray	Green	✓	✓
	CH mute (Mute)			On, Off	Off	✓	✓
	Levels			-∞, -120dB to +10dB	-40dB	✓	✓
	Max Volume			On, Off	Off	✓	✓
	Min Volume			On, Off	Off	✓	✓
	Copy			-	-	-	-
	Reset			-	-	-	-
	Link 1&2			Link 1&2, Unlink 1&2	Unlink 1&2	✓	✓
Link 3&4			Link 3&4, Unlink 3&4	Unlink 3&4	✓	✓	
Link 5&6			Link 5&6, Unlink 5&6	Unlink 5&6	✓	✓	
Link 7&8			Link 7&8, Unlink 7&8	Unlink 7&8	✓	✓	
Channel ST1, ST2	CH #			ST1, ST2	-	-	-
	Source			Bus 1/2, Bus 3/4, Bus 5/6, Bus 7/8, Bus 9/10, Bus 11/12, Direct Out 9/10	Bus 9/10, Bus 11/12	✓	✓
	Unity			0dBV, -10dBV, -33dBV	0dBV	✓	✓
	FBS			On, Off	Off	✓	✓
	EQ			On, Off	Off	✓	✓
	CMP			On, Off	Off	✓	✓
	LMT			On, Off	Off	✓	✓
	Delay	Enabled		On, Off	Off	✓	✓
	CH Name			(Maximum 30 characters (ASCII code only))	OUT ST 1, OUT ST 2	✓	✓
	CH Color			Green, Yellow, Brown, Red, Pink, Blue, Gray, Dark Gray	Green	✓	✓
	CH mute (Mute)			On, Off	Off	✓	✓
	Levels			-∞, -120dB to +10dB	-40dB	✓	✓
	Max Volume			On, Off	Off	✓	✓
	Min Volume			On, Off	Off	✓	✓
Copy			-	-	-	-	
Reset			-	-	-	-	
Feedback Suppressor Setting	OUT 1 to 8, ST 1, ST 2	Band 1 to 8	Frequency	-	-	-	-
			Band	On, Off	Off	✓	✓
		Detection		Low, Mid, High	High	✓	✓
		Response		Slow, Fast	Fast	✓	✓
		Reset		On, Off	Off	-	-
		All Static		On, Off	Off	-	-
		Copy to 12 Band EQ		On, Off	Off		

Web Remote menu items

Item name		Setting values		Default Setting	Presets Included	Resumed	
12 Band EQ Setting	OUT 1 to 8, ST 1, ST 2	Band #1 Enable		On, Off	On	✓	✓
		Band #1 Gain		-18dB to +18dB	0	✓	✓
		Band #1 Frequency		20Hz to 20kHz	20	✓	✓
		Band #1 Q value		0.3 to 60	0.75	✓	✓
		Band #1 Filter type		HPF, LSH, PEQ	PEQ	✓	✓
		Band #2 Enable		On, Off	On	✓	✓
		Band #2 Gain		-18dB to +18dB	0	✓	✓
		Band #2 Frequency		20Hz to 20kHz	30	✓	✓
		Band #2 Q value		0.3 to 60	0.75	✓	✓
		Band #3 Enable		On, Off	On	✓	✓
		Band #3 Gain		-18dB to +18dB	0	✓	✓
		Band #3 Frequency		20Hz to 20kHz	60	✓	✓
		Band #3 Q value		0.3 to 60	0.75	✓	✓
		Band #4 Enable		On, Off	On	✓	✓
		Band #4 Gain		-18dB to +18dB	0	✓	✓
		Band #4 Frequency		20Hz to 20kHz	120	✓	✓
		Band #4 Q value		0.3 to 60	0.75	✓	✓
		Band #5 Enable		On, Off	On	✓	✓
		Band #5 Gain		-18dB to +18dB	0	✓	✓
		Band #5 Frequency		20Hz to 20kHz	240	✓	✓
		Band #5 Q value		0.3 to 60	0.75	✓	✓
		Band #6 Enable		On, Off	On	✓	✓
		Band #6 Gain		-18dB to +18dB	0	✓	✓
		Band #6 Frequency		20Hz to 20kHz	500	✓	✓
		Band #6 Q value		0.3 to 60	0.75	✓	✓
		Band #7 Enable		On, Off	On	✓	✓
		Band #7 Gain		-18dB to +18dB	0	✓	✓
		Band #7 Frequency		20Hz to 20kHz	1k	✓	✓
		Band #7 Q value		0.3 to 60	0.75	✓	✓
		Band #8 Enable		On, Off	On	✓	✓
		Band #8 Gain		-18dB to +18dB	0	✓	✓
		Band #8 Frequency		20Hz to 20kHz	2k	✓	✓
		Band #8 Q value		0.3 to 60	0.75	✓	✓
		Band #9 Enable		On, Off	On	✓	✓
		Band #9 Gain		-18dB to +18dB	0	✓	✓
		Band #9 Frequency		20Hz to 20kHz	4k	✓	✓
		Band #9 Q value		0.3 to 60	0.75	✓	✓
		Band #10 Enable		On, Off	On	✓	✓
		Band #10 Gain		-18dB to +18dB	0	✓	✓
		Band #10 Frequency		20Hz to 20kHz	8k	✓	✓
Band #10 Q value		0.3 to 60	0.75	✓	✓		
Band #11 Enable		On, Off	On	✓	✓		
Band #11 Gain		-18dB to +18dB	0	✓	✓		
Band #11 Frequency		20Hz to 20kHz	16k	✓	✓		
Band #11 Q value		0.3 to 60	0.75	✓	✓		
Band #12 Enable		On, Off	On	✓	✓		
Band #12 Gain		-18dB to +18dB	0	✓	✓		
Band #12 Frequency		20Hz to 20kHz	20k	✓	✓		
Band #12 Q value		0.3 to 60	0.75	✓	✓		
Band #12 Filter type		HPF, LSH, PEQ	PEQ	✓	✓		
	Flat		-	-	-	-	
	Recall EQ Preset		-	-	-	-	
	Save EQ Preset		-	-	-	-	
	Reset		-	-	-	-	

Web Remote menu items

Item name			Setting values	Default Setting	Presets Included	Resumed
Dynamics Setting	Pre/Post		Pre, Post	Post	✓	✓
	Comp/DeEsser		Comp, DeEsser	Comp	✓	✓
	Compressor	Ratio	1:1.4, 1:2, 1:4, 1:6, 1:10, 1:∞	1:2	✓	✓
		Threshold	-60 to 0dB	-10	✓	✓
		Attack	0ms, 0.25ms, 0.5ms, 1ms, 2ms, 4ms, 8ms, 16ms, 32ms, 100ms	1	✓	✓
		Release	50ms, 100ms, 200ms, 400ms, 800ms, 1000ms, 2000ms	400	✓	✓
	Output	Gain	+10dB to -10dB	0	✓	✓
	Limiter	Threshold	-60dB to 0dB	0	✓	✓
	DeEsser	Band #1 Frequency	20Hz to 20kHz	1.6k	✓	✓
		Band #1 Q value	0.3 to 60	0.75	✓	✓
		Band #1 Gain	0dB to +18dB	0	✓	✓
		Band #1 Filter type	HPF, LSH, PEQ	PEQ	✓	✓
		Band #2 Frequency	20Hz to 20kHz	1.6k	✓	✓
		Band #2 Q value	0.3 to 60	0.75	✓	✓
		Band #2 Gain	0dB to +18dB	0	✓	✓
Band #2 Filter type		HPF, LSH, PEQ	PEQ	✓	✓	
	Lowcut	On, Off	On	✓	✓	
	Listen	On, Off	Off	-	-	

USB OUT

Item name			Setting values	Default Setting	Presets Included	Resumed
USB OUT	Bus Select	OUT 1	OFF, Bus 1 to 12	OFF	✓	✓
		OUT 2	OFF, Bus 1 to 12	OFF	✓	✓
	Level		-∞, -120dB to 0dB	0	✓	✓

Oscillator

Item name			Setting values	Default Setting	Presets Included	Resumed
Oscillator	Enabled		On, Off	Off	-	-
	Source		Sine Wave, Pink Noise	Sine Wave	-	-
	Frequency		100Hz, 1kHz, 10kHz	1kHz	-	-
	Level		-∞, -120dB to 0dB	-∞	-	-
	Assign	OUT 1 to 8, ST 1, ST 2	Enable, Disable	Disable	-	-

CMP/FBS

Item name			Setting values	Default Setting	Presets Included	Resumed
CMP/FBS	IN 1 to 10		Off, CMP, FBS	Off	✓	✓
	OUT 1 to 8		Off, CMP, FBS	Off	✓	✓
	ST1, ST2		Off, CMP, FBS	Off	✓	✓

Limiter

Item name			Setting values	Default Setting	Presets Included	Resumed
Limiter	OUT 1 to 8		Off, Limiter	Off	✓	✓
	ST1, ST2		Off, Limiter	Off	✓	✓

Copy

Item name			Setting values	Default Setting	Presets Included	Resumed
Copy			-	-	-	-

Web Remote menu items

Settings & Maintenance

System Settings

General

Item name		Setting values	Default Setting	Presets Included	Resumed
Device Name	Device Name	(Maximum 30 characters (ASCII code only))	ATDM-1012	-	✓
	Device ID	0 to 255	0	-	✓
	Header Color	White, Green, Yellow, Orange, Purple, Cyan	White	-	✓
Audio-Technica LINK Mode	Audio-Technica LINK Mode	Primary, Extension	Primary	-	✓
Front Panel Display	Error Notice	On, Off	On	-	✓

Network

Item name		Setting values	Default Setting	Presets Included	Resumed
Network Configuration*	Mode	Switched, Redundant Audio, Split	Switched	-	✓
	Latency	250usec, 500usec, 1msec, 2msec, 5msec	1msec	-	✓
Dante & Audio Port Settings*	IP Config Mode (Primary)	Auto, Static	-	-	✓
	IP Address (Primary)	0.0.0.0 to 255.255.255.255	-	-	✓
	Subnet Mask (Primary)	0.0.0.0 to 255.255.255.255	-	-	✓
	Gateway Address (Primary)	0.0.0.0 to 255.255.255.255	-	-	✓
IP Control & Web Remote Port Settings	IP Config Mode	Auto, Static	Auto	-	✓
	IP Address	0.0.0.0 to 255.255.255.255	-	-	✓
	Subnet Mask	0.0.0.0 to 255.255.255.255	-	-	✓
	Gateway Address	0.0.0.0 to 255.255.255.255	-	-	✓
Allow Discovery	Enabled	On, Off	On	-	✓
IP Control Settings	Port Number	00001 to 65535	17300	-	✓
	Notification	On, Off	Off	-	✓
	Audio Level Notification	On, Off	Off	-	✓
	Multicast Address	0.0.0.0 to 255.255.255.255	225.0.0.100	-	✓
	Multicast Port Number	00001 to 65535	17000	-	✓
NTP Settings	Enabled	On, Off	Off	-	✓
	Server Address	0.0.0.0 to 255.255.255.255	-	-	✓
	Port Number	00001 to 65535	123	-	✓
	Time Zone	UTC -12:00 to +14:00	UTC 0:00	-	✓
	Daylight Saving Time	On, Off	Off	-	✓
	Start Date & Time	1/1 to 12/31, 0:00 to 23:00	3/27, 2:00	-	✓
	End Date & Time	1/1 to 12/31, 0:00 to 23:00	10/30, 2:00	-	✓

* Displayed only for ATDM-1012DAN.

User Access

Item name		Setting values	Default Setting	Presets Included	Resumed
Default Front Panel Mode	Default Front Panel Mode	Operator, Administrator	Administrator	-	✓
Login Password	Administrator Password	On, Off (Minimum 4, Maximum 8 characters (alphabet and number only))	Off	-	✓
Operator Page Permissions	Restrict Access	On, Off	Off	-	✓
	Permission IP 1 to Permission IP 5	0.0.0.0 to 255.255.255.255	-	-	✓
	Operator Page Permissions (1 to 8)	On, Off	Off	-	✓

Web Remote menu items

Audio

Item name		Setting values	Default Setting	Presets Included	Resumed
Audio System	Gain Unit Type	dBu/dBV, dB	dB	-	✓
	Delay Unit Type	ms, m, Ft	ms	-	✓
	Input PEQ/DYN Display	EQ, DYN	EQ	-	✓
	Virtual Mic Mode	Off, Virtual Mic 1, Virtual Mic 2, Virtual Mic 1&2	Off	-	✓

Front Panel

Item name		Setting values	Default Setting	Presets Included	Resumed
Levels	INPUT: 1 to 10CH, ST1, ST2 OUTPUT: 1 to 8CH, ST1, ST2	Enable, Disable	Enable	-	✓
Mute	INPUT: 1 to 10CH, ST1, ST2 OUTPUT: 1 to 8CH, ST1, ST2	Enable, Disable	Enable	-	✓
LED Dimmer	Enabled	On, Off	Off	-	✓
Front Panel Restrictions	Enable Preset Recall	On, Off	On	-	✓

Utilities

Item name		Setting values	Default Setting	Presets Included	Resumed
Firmware Update		-	-	-	-
Language Pack Install		-	-	-	-
Reset All Settings to Default		-	-	-	-

Web Remote menu items

Operator Access

Operator Page

Item name				Setting values	Default Setting	Presets Included	Resumed	
Multi Operator Page	Enabled			On, Off	Off	-	✓	
Array Mic Switch LINK	Enabled			On, Off	Off	-	✓	
Fader Settings	Page Name			(Maximum 30 characters)	Page 1	✓	✓	
	Hide from List			On, Off	Off	✓	✓	
	Fader 1 to 8	Fader			On, Off	Off (Fader 1: On)	✓	✓
		Mute			On, Off	Off (Fader 1: On)	✓	✓
	Icon			Mic, Aux, PC, Chat, Spk, Rec	Mic	✓	✓	
	Name			(Maximum 10 characters (ASCII code only))	Mic	✓	✓	
	Levels			0 to 100	70	✓	✓	
	Min Volume			On, Off	Off	✓	✓	
Max Volume			On, Off	Off	✓	✓		
Assign			INPUT: 1 to 10CH, ST1, ST2 OUTPUT: 1 to 8, ST1 ST2 Fader Group: A to H	Off (INPUT 1: On)	✓	✓		
Operator Page Restrictions	Preset Recall			On, Off	On	✓	✓	
	Number Of Presets			1 to 8	8	✓	✓	
	Resume Fader Position			On, Off	Off	✓	✓	
	Logout Button			On, Off	On	✓	✓	
	Tascam Button			On, Off	On	✓	✓	
	Transport Layout			Layout 1, Layout 2	Layout 1	✓	✓	

Presets

Presets

Item name				Setting values	Default Setting	Presets Included	Resumed
Presets	Preset Name			(Maximum 30 characters)	Preset 1 to 8	✓	✓
	Boot Up Preset			1 to 8, Non	Non	-	✓
Preset Recall LINK	Preset Recall LINK			On, Off	On	-	✓
	Tascam Preset LINK			On, Off	Off	-	✓

Menu items

Partial Preset

Item name				Setting values	Default Setting	Presets Included	Resumed	
Partial Preset	Preset Name			(Maximum 30 characters)	Partial Preset 1 to 40	✓	✓	
Partial Preset Parameters	All Parameters			On, Off	Off	-	✓	
	Input	AEC Reference		On, Off	Off	-	✓	
		Input CH	Level/Mute		On, Off	Off	-	✓
			Smart Mix/AEC		On, Off	Off	-	✓
			Group		On, Off	Off	-	✓
		Sub input CH	Level/Mute		On, Off	Off	-	✓
			Group		On, Off	Off	-	✓
					On, Off	Off	-	✓
	Matrix	NC Bus Select		On, Off	Off	-	✓	
		Input CH	Bus Assign		On, Off	Off	-	✓
		Sub Input CH	Bus Assign		On, Off	Off	-	✓
	Output	Output CH	Level/Mute		On, Off	Off	-	✓
Group				On, Off	Off	-	✓	
Operator Page	Fader	Level/Mute		On, Off	Off	-	✓	

4 Band EQ Library

Item name				Setting values	Default Setting	Presets Included	Resumed
4 Band EQ Library	EQ Preset Name			(Maximum 30 characters)	EQ Preset 1 to 20	-	✓
	EQ Preset			-	-	-	-
	Library			-	-	-	-

12 Band EQ Library

Item name				Setting values	Default Setting	Presets Included	Resumed
12 Band EQ Library	EQ Preset Name			(Maximum 30 characters)	EQ Preset 1 to 20	-	✓
	EQ Preset			-	-	-	-
	Library			-	-	-	-

Logging

Logging

Item name				Setting values	Default Setting	Presets Included	Resumed
Logging	Enabled			On, Off	On	-	✓
	Destination			Internal, Syslog	Internal	-	✓
	Log File			-	-	-	-

System Info

System Info

Item name				Setting values	Default Setting	Presets Included	Resumed
System Info				-	-	-	-

Troubleshooting

If you encounter a problem, please check the following.

- Check whether all connections are correct.
- Check whether the system is being operated according to the instructions provided in the manual.
- Check whether the external devices are functioning properly. Check the devices without connecting them to the product.
- Restart the network devices.

If any of the devices in the system are not functioning properly, check the troubleshooting tips below.

If none of the tips apply, please contact your local Audio-Technica dealer.

You may be asked to provide the version of your firmware. Please check in advance and have the firmware version handy.

To find the firmware version on the product: Refer to P.16 and P.19.

To find the firmware version via Web Remote: Refer to P.53.

ATDM-1012/ATDM-1012DAN unit

Symptom	Cause/Action
The power does not turn on.	Check whether the power cable is connected correctly.
The connected microphone does not function.	Check whether the microphone is connected correctly.
	Check whether Mic is selected as the input type (Mic/Line).
	Check whether the phantom power is turned on when using a condenser microphone.
	Check the gain.
	Check the input level.
No sound comes out of the connected speaker. The sound is distorted.	Check the connections of all devices.
	Check whether the phantom power is turned on when using a condenser microphone.
	Check whether a device that does not require phantom power is connected with the phantom power turned ON. If phantom power is supplied to a device that does not require it, the device may malfunction.
	Check and adjust the settings on the connected amplifier.
	Check whether the balanced cable is damaged.
	Make sure that the balanced cable is securely inserted all the way.
	Check whether the input and output terminals are connected correctly.
	Check whether the pin assignments are correct for the input and output terminals.
	Check that the input level and/or the output level is not set too low.
	Check whether mute is turned ON.
The sound is strange.	Adjust the input gain.
	If the sound is muffled or the volume is not sufficient, check the setting of each equalizer.
The howling cannot be suppressed.	Check the setting of the FBS (feedback suppressor). If howling that exceeds the number of filters is occurring, the howling cannot be controlled completely.

Troubleshooting

Web Remote

Symptom	Cause/Action
You cannot "locate" the product.	Check the connections of the product and the control device, such as a computer.
	Check whether the product and the control device, such as a computer, are connected to the same network.
	Check the firewall settings.
Web Remote cannot be opened from a control device, such as an iPad or another tablet.	Check whether the control device is connected to the correct access point.
	Check whether the product and the control device, such as an iPad or another tablet, are connected to the same network.
You forgot the password.	Reset the password based on the following procedure: Press the power button to start the product. While pressing the BACK button, turn the dial button three clicks to the right. While pressing the BACK button, turn the dial button three clicks to the left. While pressing the BACK button, press the dial button. The Web Remote password is reset. Login again to Web Remote and set the password again as needed.

Error messages

Symptom	Cause	Action
Resume Data Error	Importing the resume data failed. The product started with the previous or default settings.	Restart the product, and check whether the same error occurs.
Preset Data Error	Importing the preset data failed. The preset data is the one that was successfully imported last time or the default.	Restart the product, and check whether the same error occurs.
Library Data Error	Importing the EQ library data failed. The product started with the previous or default settings.	Restart the product, and check whether the same error occurs.
Audio-Technica LINK Connection Error	An error occurred during the communication with an ATDM-1012/ATDM-1012DAN that is connected via Audio-Technica LINK. The operation of Audio-Technica LINK was stopped.	Check for any network connection problem.
Audio-Technica LINK OFF	The Audio-Technica LINK was canceled, and its operation was stopped.	Check for any network connection problem.
Detect Exceeded Link Units	The number of ATDM-1012/ATDM-1012DAN units connected exceeded the maximum number of units that can be connected. The operation of Audio-Technica LINK was stopped.	Check the number of units connected.
Detect Multi Primary Units	More than one primary unit of ATDM-1012/ATDM-1012DAN was detected. The operation of Audio-Technica LINK was stopped.	Set only one ATDM-1012 unit as the primary.
Detect Ring Connection	A ring connection was detected. The operation of Audio-Technica LINK was stopped.	Do not connect units in a ring pattern. Make sure to leave one of the two LINK terminals at both ends of the connected ATDM-1012 devices open.
Network Communication Error	A network communication error occurred.	Check for any network connection problem.
	An IP command communication error occurred.	
Access from Non Permitted Device	A device not permitted to access was connected.	Check for any network connection problem.
File Import Failed	Importing the preset file failed.	Check whether the file format is correct. The network connection may have been disconnected.
File Export Failed	Exporting the preset file failed.	The network connection may have been disconnected.
Failed	An unknown system failure occurred.	Perform the operation again, and check whether the same error occurs.
Failed. Please turn power OFF.	An error occurred during the firmware update.	Restart the product, and check whether the same error occurs.
Data acquisition error.	Acquisition of data via web remote failed.	Perform the operation again, and check whether the same error occurs.
USB Disconnected	The USB connection with the PC is not established.	Check whether the USB connection with the PC is proper. Connect the USB to another PC, and check whether the same error occurs.
Synchronous Disconnect	Synchronization with the PC failed.	Check whether the USB connection with the PC is proper. Connect the USB to another PC, and check whether the same error occurs.
Cannot COPY	The data cannot be copied because the EQ preset is full.	Check whether there is space in the EQ preset.
	Copying of the bands in static state to the 12-band EQ failed.	The bands for which EQ is set to OFF on the 12-band EQ side are to be copied. Check the settings.

Dimensions

ATDM-1012

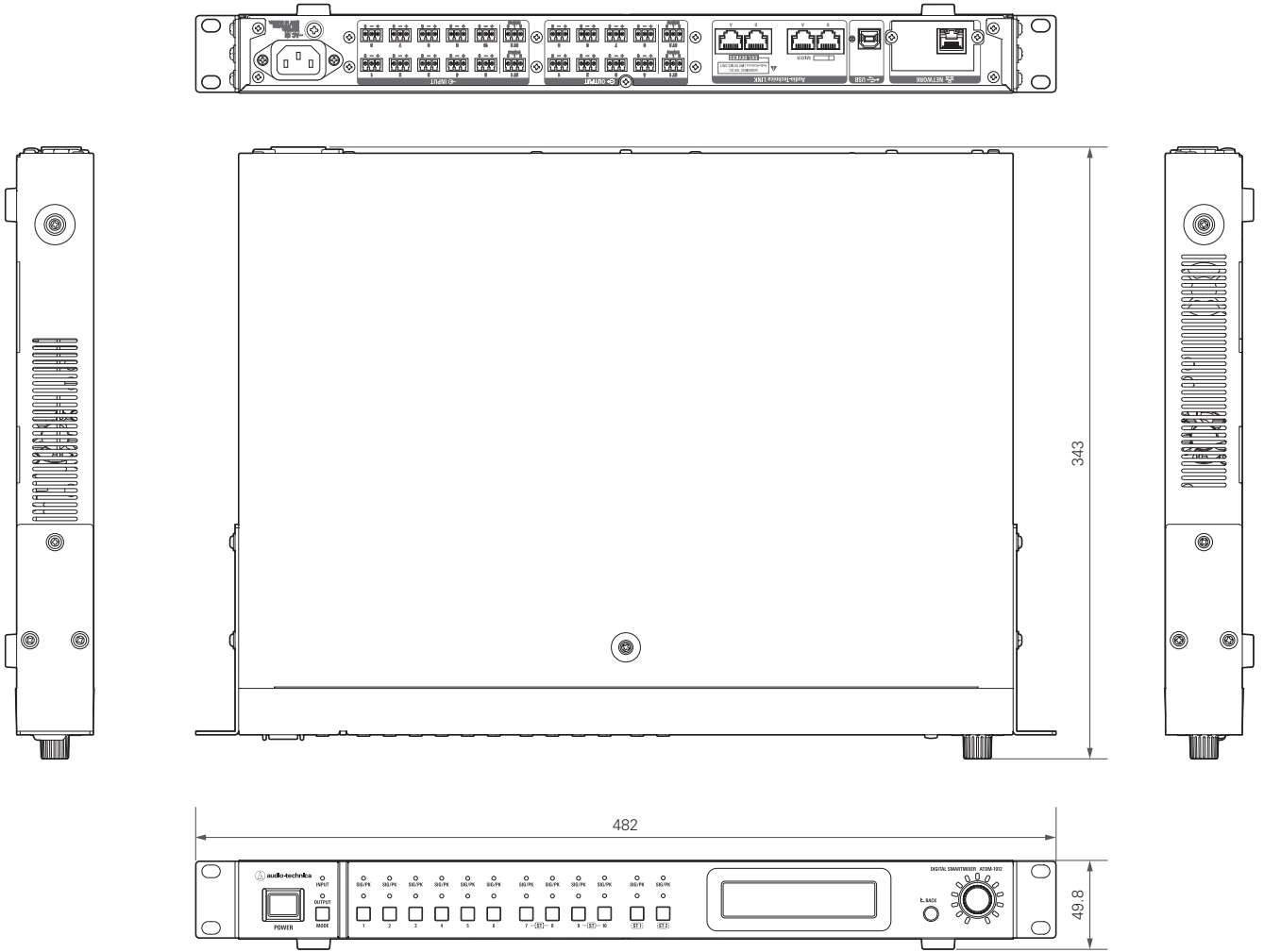

(Unit: mm)

Dimensions

ATDM-1012DAN

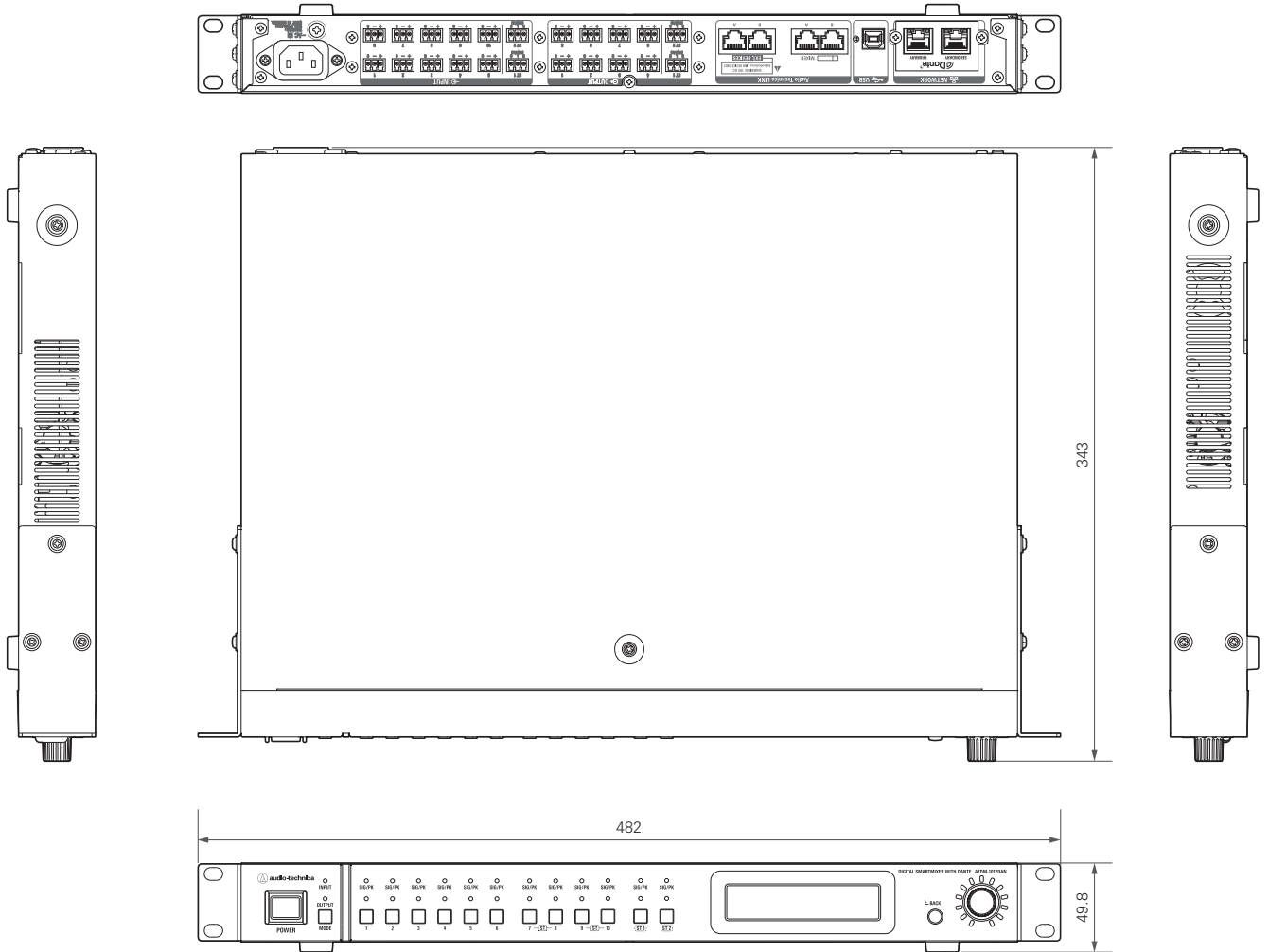

(Unit: mm)

Specifications

General specifications

Power supply	100 to 240 V AC (50/60 Hz)	
Power consumption	65 W	
Operating temperature range	0 to 40°C (32 to 104°F)	
Operating humidity range	25 to 85% (with no condensation)	
Dimensions (including protrusions)	482 mm (19") × 343 mm (14") × 49.8 mm (2.0") (W×D×H)	
Weight	3.6 kg (7.9 lbs)	
Finish	Front Panel	Black with silver lines
	Top/rear/sides	Black

Audio

Frequency characteristics	20 Hz to 20 kHz (MIC -16 dBu)	+1.0/-1.0 dB
	20 Hz to 20 kHz (MIC -60 dBu)	+1.0/-2.0 dB
	20 Hz to 20 kHz (LINE 24 dBu)	+1.0/-1.0 dB
	20 Hz to 20 kHz (LINE -40 dBu)	+1.0/-2.0 dB
Dynamic range	112 dB or higher, A-weighted/ST	
S/N ratio	92 dB or higher, A-weighted/ST	
Headroom	20 dB or higher	
Input referred noise	-127 dBu or less, $R_s = 150$ ohm	
Common-mode rejection ratio	80 dB or higher, 1 kHz	
Residual noise	-88 dBu or less, A-weighted	
Maximum gain	64 dB	
Channel separation	-80 dB or less, 1 kHz unity	
Total harmonic distortion	0.03% or less, 1 kHz unity	
Analog input	MIC max.	0 dBu
	MIC unity	-40 dBu
	LINE max.	+24 dBu
	LINE unity	+4 dBu / 0 dBV / -10 dBV / -20 dBV, Switchable
	ST max.	+20 dBV
	ST unity	0 dBV / -10 dBV / -20 dBV, Switchable
Analog output	OUTPUT 1 to 8 max.	+24 dBu / +20 dBV / +10 dBV
	OUTPUT 1 to 8 unity	+4 dBu / 0 dBV / -10 dBV, Switchable
	OUTPUT ST max.	+20 dBV / +10 dBV / -13 dBV
	OUTPUT ST unity	0 dBV / -10 dBV / -33 dBV, Switchable

Specifications

Other

Phantom power		+48 V (Euroblock input)
PAD (Attenuation level)		-24 dB
I/O connector	MIC/LINE INPUT 1 to 10	Euroblock connectors (3-pin)
	ST INPUT 1/2	Euroblock connectors (3-pin)
	OUTPUT 1 to 8	Euroblock connectors (3-pin)
	ST OUTPUT 1/2	Euroblock connectors (3-pin)
Level indicator	SIGNAL/PEAK	1 point (Red/Yellow/Green)
	Peak indicate	-5 to 0 dB
	Peak hold time	2 sec.
Remote control	IP protocol	RJ-45×1 pc
	IP address	192.168.33.102 (factory default)
	Communication speed	100 Mbps
Network	ATDM-1012	Network port
	ATDM-1012DAN	Dante Primary/Secondary ports
Link I/O	IP protocol	RJ-45 × 4 pcs.
	Communication speed	100 Mbps
USB Type B	Channel	Stereo input x 1 ch, stereo output x 1 ch (24-bit)
	Communication speed	High-speed (480 Mbps)
AEC	Echo cancellation amount	Max. 90 dB
	Tail length	Max. 400 msec
A/D converter	Resolution	24-bit
	Dynamic range	115 dB
D/A converter	Resolution	24-bit
	Dynamic range	115 dB
Accessories		Euroblock connector ×22, power cable

Input/Output specifications

Analog input specifications

Input terminal		Gain	Load impedance	Input level			Connector	Balanced/Unbalanced
				Minimum value	Nominal value	Maximum value		
MIC/LINE 1 to 10	MIC	20 to 60 dB	1.6 kΩ	-60 dBu	-40 dBu	-20 dBu	Euroblock connector	Balanced
	LINE	20 to 60 dB	10 kΩ	-40 dBu	+4 dBu / 0 dBV / -10 dBV / -20 dBV	+24 dBu	Euroblock connector	Balanced
SR1, 2 (L/R)		-	10 kΩ	-	0 dBV / -10 dBV / -20 dBV	+20 dBV	Euroblock connector	Unbalanced

Analog output specifications

Output terminal	Load impedance	Output level			Connector	Balanced/Unbalanced
		Minimum value	Nominal value	Maximum value		
BAL 1 to 8	150 Ω	-	+4 dBu / -10 dBV / 0 dBV	+24 dBu	Euroblock connector	Balanced
UNBAL 1, 2 (L/R)	150 Ω	-	0 dBV / -10 dBV / -33 dBV	+20 dBV	Euroblock connector	Unbalanced

System diagram

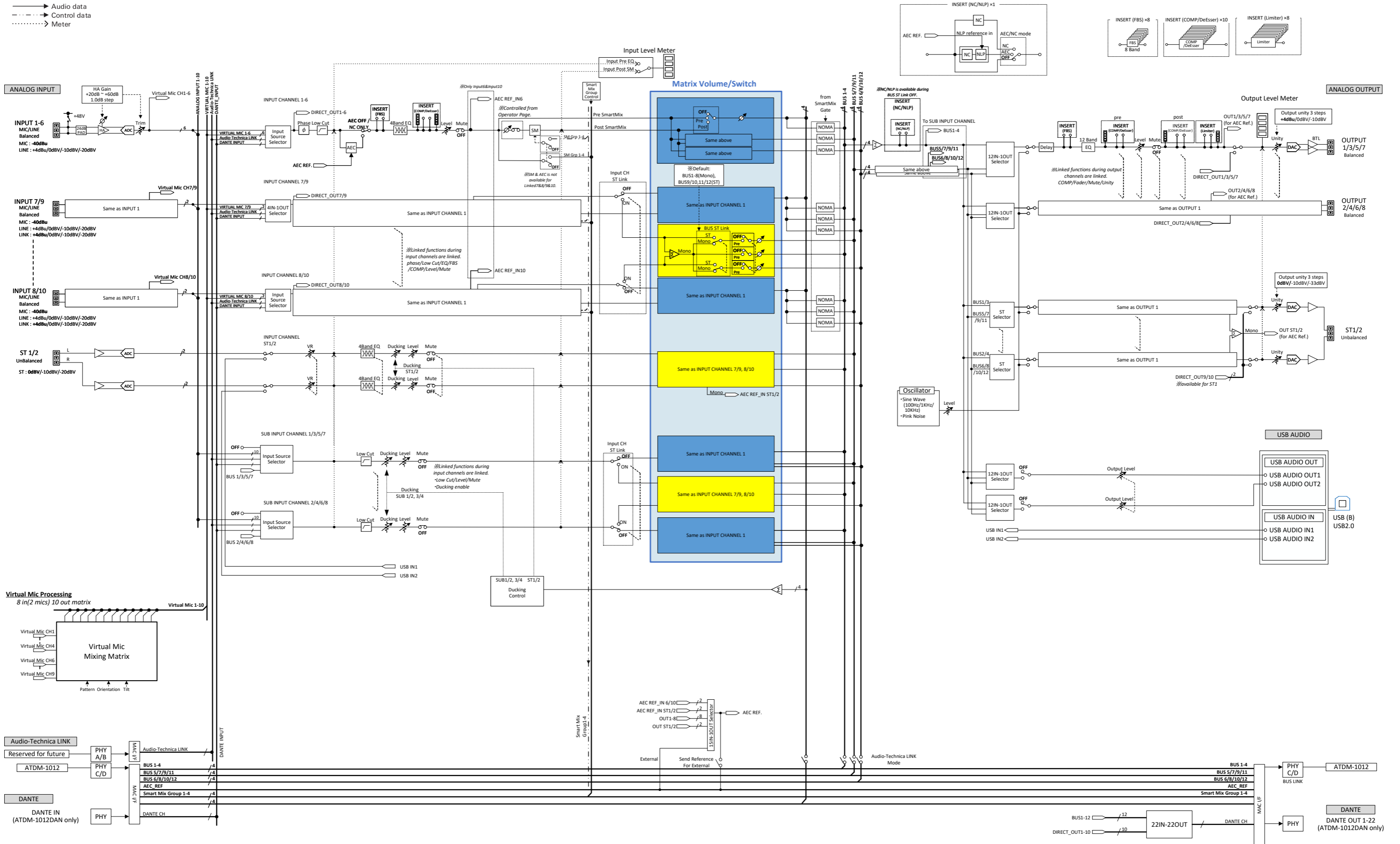

Audio-Technica Corporation

2-46-1 Nishi-naruse, Machida, Tokyo 194-8666, Japan

www.audio-technica.com

©2022 Audio-Technica Corporation

Global Support Contact: www.at-globalsupport.com

220500040-02-02

ver.1 2021.04.15
ver.2 2022.04.15